

Preview 2019

Elesi Luce

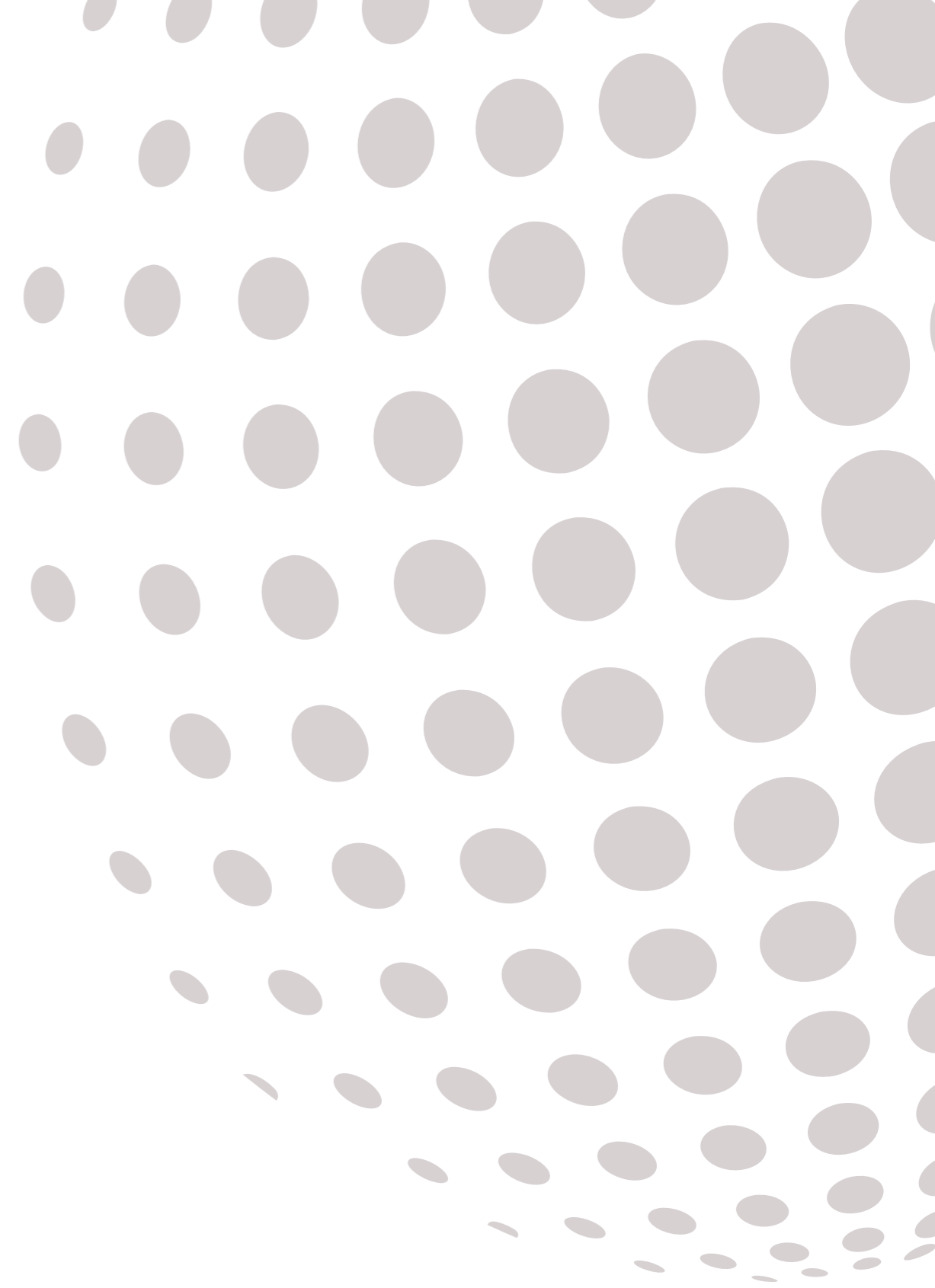

Elesi Luce

Interpretare il cambiamento



Di stagione in stagione, Elesi Luce consolida i propri successi anche grazie alla grande attenzione alle trasformazioni tecnologiche tenendo conto dei cambiamenti del gusto del pubblico. Il futuro è quello che si costruisce giorno per giorno. Lo sanno bene Silvia Betteto e il papà Maurizio che sovrintendono un team molto affiatato. In un clima di positiva propositività da semplice impresa hanno trasformato l'azienda, collezione dopo collezione, in una autentica fucina di idee.

➤ **Interpret change** From season to season, Elesi Luce consolidates its success also due to its attention to technological transformations, taking account of changes in public taste.

The future is built day by day. Silvia Betteto and her father Maurizio, who supervise a very close-knit team, are well aware of this. In a positive pro-active atmosphere, they have transformed the business, collection by collection, from a simple firm into a real hotbed of ideas.

➤ **Interpréter le changement** D'une saison à l'autre, Elesi Luce conforte son succès, grâce également à la forte attention qu'elle accorde aux transformations technologiques tenant compte de l'évolution des goûts du public.

Le futur se construit de jour en jour. Et Silvia Betteto et son père Maurizio, à la tête d'une équipe particulièrement soudée, le savent bien. C'est ainsi qu'ils ont réussi, dans un climat de proactivité positive, à transformer leur entreprise en une authentique forge d'idées, collection après collection

➤ **Interpretieren die Veränderung** Elesi Luce konsolidiert seinen Erfolg ständig nicht zuletzt dank des großen Augenmerks, das der italienische Leuchtspezialist auf technischen Fortschritt und Zeitgeist legt. Zukunft ist das, woran man Tag für Tag arbeitet. Silvia Betteto und ihr Vater Maurizio, die ein perfekt eingespieltes Team führen, wissen das ganz genau. In einem positiven, proaktiven Klima haben sie denn ihr Unternehmen mit jeder Kollektion ein Stück weiter zu einer formidablen Ideenschmiede ausgebaut.

Una nuova strada

Accanto alla produzione più tradizionale, capace di inserirsi nelle ambientazioni tipiche del vivere d'oggi, per scelta Elesi Luce ha voluto guardare ora al design come modo sempre più attuale per offrire una nuova immagine di sé. E' nata sotto questa spinta la collezione Versailles '18, frutto della attenta progettazione dell'architetto Paolo Francia. Espressione di un classico rivisitato che può trovare spazio negli ambienti più tradizionali ma che, grazie alla propria sobria attualità data dalle nuove tecnologie led utilizzate, si propone come una autentica "svolta" per il mercato.

➤ **A new path** Alongside the more traditional production, which blends in with typical contemporary furnishing schemes, Elesi Luce has now chosen to consider design as a way of projecting a new image of itself. The result of this approach is the Versailles '18 collection, designed by the architect Paolo Francia. The expression of a classic style revisited, which blends in with traditional furnishing schemes but also, due to the essential modern style of the new LED technologies used, represents a turning point for the market.

➤ **Une nouvelle approche** Parallèlement à une production plus traditionnelle capable de s'intégrer dans les atmosphères typiques de la vie contemporaine, Elesi Luce a sciemment choisi de penser au design en tant que moyen toujours plus actuel pour offrir une nouvelle image de soi. Une telle approche a donné naissance à Versailles '18, fruit d'un rigoureux projet de l'architecte Paolo Francia. Expression d'un classique revisité capable de s'intégrer dans les environnements les plus traditionnels, cette collection représente toutefois un véritable tournant dans le marché pour la sobriété de son actualité venant de l'utilisation des nouvelles technologies DEL.

➤ **Eine neue Richtung** Neben den bereits bekannten Serien für einen zeitgemäßen Einrichtungsstil wollte Elesi Luce auch ein Design-Produkt schaffen und damit ein neues Bild von sich zeichnen. So ist aus der Feder des Architekten Paolo Francia die Kollektion Versailles '18 entstanden, als Ausdruck eines neuinterpretierten Klassikers, der sich zwar in ein traditionelles Ambiente gut integrieren lässt, aber aufgrund seiner LED-Technologie und schlichten Moderne eine Marktneuheit darstellt.

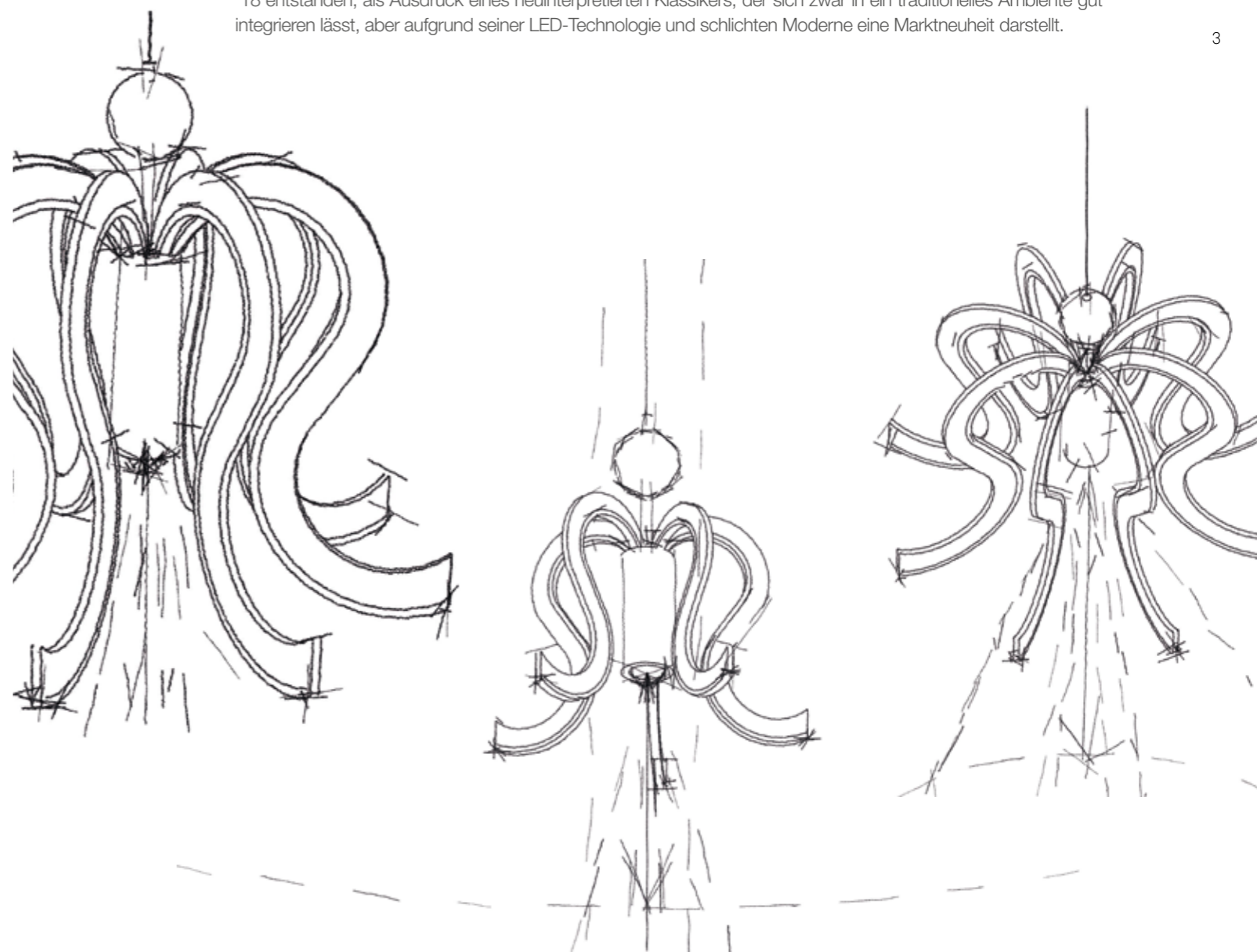

Sotto una nuova luce

L'utilizzo sempre più attuale dei led integrati si unisce alla ricerca di materiali in grado di esaltare la bellezza della luce. Questa peculiarità si rivela nell'ampia gamma di lampade proposte in questo inizio 2018, in particolare nell'utilizzo combinato del plexiglass con micro-puntinatura al laser e led COB.

➤ **In a new light** The use of the latest integrated LEDs is combined with the search for materials that enhance the beauty of the light. This feature is evident in the wide range of lights offered at the beginning of this year, in particular in the combined use of Plexiglas with laser micro-dot engraving and COB LEDs.

➤ **Sous une nouvelle lumière** L'utilisation toujours plus moderne des DEL intégrées s'associe à la recherche de matériaux en mesure d'exalter la beauté de la lumière. Cette caractéristique se reflète dans la vaste gamme de luminaires proposés début 2018, et en particulier dans l'utilisation combinée du Plexiglass micro pointillé au laser et des DEL COB.

➤ **Unter einem anderen Licht** Der Einsatz von integrierten LEDs verbindet sich mit der Suche nach Materialien, die in der Lage sind, die Schönheit von Licht zu betonen. Anfang 2018 wurde eine Reihe von Leuchten mit ins Programm genommen, die diese Besonderheit aufs Beste verkörpern und zwar durch die Kombination von Plexiglas mit Laser-Mikrostrukturierung und COB-LEDs.



Attenzione alla progettazione della luce

Allineata con le richieste di architetti e progettisti che ricercano modi nuovi di arredare e illuminare suscitando emozione, Elesi Luce contribuisce alla progettazione fornendo i supporti necessari: dati fotometrici e BIM. Oltre agli strumenti tecnici, il servizio di customer care è sempre a disposizione per check sui prodotti, personalizzazioni, disponibilità, tempistiche di evasione. ➤ **Attention to lighting design** In line with the demands of architects and designers looking for exciting new ways of furnishing and lighting, Elesi Luce contributes to design by providing the necessary supports: photometric data and BIM. In addition to the technical tools, the customer care service is always on hand for product checks, customizations, availability and order clearance times. ➤ **Un grand soin dans la conception de la lumière** En ligne avec les exigences d'architectes et de concepteurs à la recherche de nouveaux

moyens de décorer et d'éclairer en suscitant une émotion, Elesi Luce contribue à la conception en fournissant tous les supports nécessaires : des données photométriques à la modélisation BIM. À ces outils techniques s'ajoute un service d'assistance à la clientèle toujours disponible pour vérifier les produits, les personnalisations, les disponibilités et les délais de finalisation. ➤ **Lichtplanung im Fokus** Architekten und Planer sind stets auf der Suche nach neuen Einrichtungs- und Beleuchtungslösungen, die Emotionen wecken. Elesi Luce weiß das und leistet seinen Beitrag zur Planung durch Bereitstellung wichtiger Informationen: photometrische Daten und BIM-Daten. Neben den technischen Instrumenten liefert der Customer Care-Service von Elesi auch Dienstleistungen wie Produkte-Check, Personalisierung und Zeitplanung.

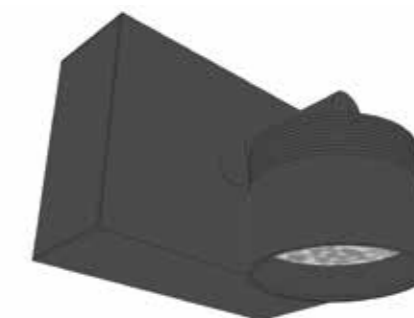

Un segno che distingue

Un piccolo importante segnale caratterizza l'evoluzione di Elesi Luce: la griffe che viene apposta nei propri prodotti evidenzia una identità che diventa garanzia di qualità, di buon gusto, di accuratezza nei dettagli da condividere con chi sceglie Elesi Luce. ➤ **A distinguishing mark** A small but important sign characterizes the evolution of Elesi Luce: the logo affixed to its products highlights an identity that guarantees quality, good taste and attention to detail, elements that Elesi Luce shares with its customers. ➤ **Une griffe qui fait la différence** Une petite — mais ô combien importante — marque caractérise l'évolution d'Elesi Luce : la griffe apposée sur ses produits souligne une identité qui s'impose comme garantie de qualité, de bon goût, de soin dans les détails, à partager avec ceux qui choisissent Elesi Luce. ➤ **Ein Zeichen, das den Unterschied macht** Ein kleines, aber wichtiges Zeichen charakterisiert die Weiterentwicklung von Elesi Luce: Das auf die Produkte aufgebrachte Logo ist Zeugnis für eine Identität, die zur Garantie für Qualität, Stil und Liebe zum Detail wird.





Custom made

La sfida da raccogliere, imposta dai veloci cambiamenti dei mercati, è rappresentata oggi dalla capacità di dialogare con la committenza, rappresentata sempre più da esperti del contract, architetti e arredatori coinvolti nella progettazione di nuove strutture.

Elesi Luce va affermandosi oggi come partner nel settore del "chiavi in mano" affrontando progetti anche molto complessi, realizzando lampade su disegno del committente, forte della capacità di dialogo, della possibilità di prototipare in tempi rapidi e di progettare soluzioni "ad hoc". Proponendo spesso soluzioni vincenti, senza per altro perdere di vista i budget indicati, i tempi imposti e la volontà di offrire sempre massima assistenza. **Custom made** Rapid market changes pose challenges, first and foremost the ability to dialogue with the customers who are increasingly represented by contract experts, architects and furnishers involved in the design of new structures.

Elesi Luce is making a name for itself as a partner in the turnkey sector, also tackling very complex projects, creating lighting products to customer specifications, relying on its ability to dialogue, produce prototypes rapidly and meet specific needs. This often results in winning solutions, without losing sight of the budget, the timescales required and the desire to offer maximum customer support at all times. **Du sur-mesure** Imposé par l'évolution rapide des marchés, le défi à relever est aujourd'hui

représenté par la capacité de dialoguer avec des commettants qui sont de plus en plus des experts dans les fournitures pour les collectivités, mais aussi des architectes et des décorateurs impliqués dans la conception de nouvelles structures.

Forte de sa capacité de dialogue, de ses compétences dans la réalisation de prototypes dans les délais les plus brefs et dans la conception de solutions sur mesure, Elesi Luce s'impose aujourd'hui comme partenaire dans le secteur du « clé en main », affrontant des projets qui sont même particulièrement complexes, et réalisant des luminaires d'après les dessins du commettant. Elesi Luce propose des solutions gagnantes, toujours respectueuses des budgets indiqués et des délais imposés, en offrant une assistance à 360°. **Fertigung nach Kundenwünschen** Die Herausforderung, die es anzunehmen gilt, besteht in der Dialogfähigkeit mit den Auftraggebern, die heute zunehmend mit der Planung von neuen Objekten befasste Contract-Experten, Architekten und Einrichter sind. Elesi Luce versteht sich als Partner für den Bereich „schlüsselfertige Lieferungen“ und misst sich auch gerne an komplexen Projekten, bei denen die Leuchten nach Kundenvorgabe zu fertigen sind: Dialogfähigkeit, schnelle Prototypisierung und maßgeschneiderte Lösungen machen es möglich. Erfolgsorientiert handelt Elesi dabei so, dass Budget, Zeitrahmen und Betreuung niemals außer Acht gelassen werden.

Indice

Index



Versailles '18 8



Air 20



Kyte 38



Rondaj 48

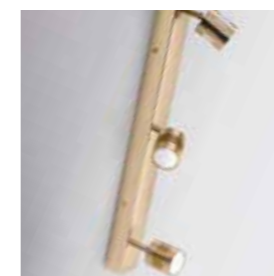

Imperium 56

Versailles '18

La collezione Versailles' 18 si propone di reinterpretare in chiave assolutamente moderna un classico della tradizione.

The Versailles' 18 light collection reinterprets the past with a series featuring unique, ultra-modern but at the same time recalling the beauty of traditional lighting.

La collection de lustres Versailles' 18 se propose de réinterpréter le passé sous un angle résolument moderne, évoquant néanmoins la beauté des lustres classiques d'autrefois.

Die Leuchten-Kollektion Versailles' 18 widerspiegelt die Freude am Spiel mit Vergangenem. Durch ihre technischen Merkmale zweifelsohne der Moderne verpflichtet ist sie doch in der Lage, die Faszination alter Lüster heraufzubeschwören.





Versailles '18

Versailles '18

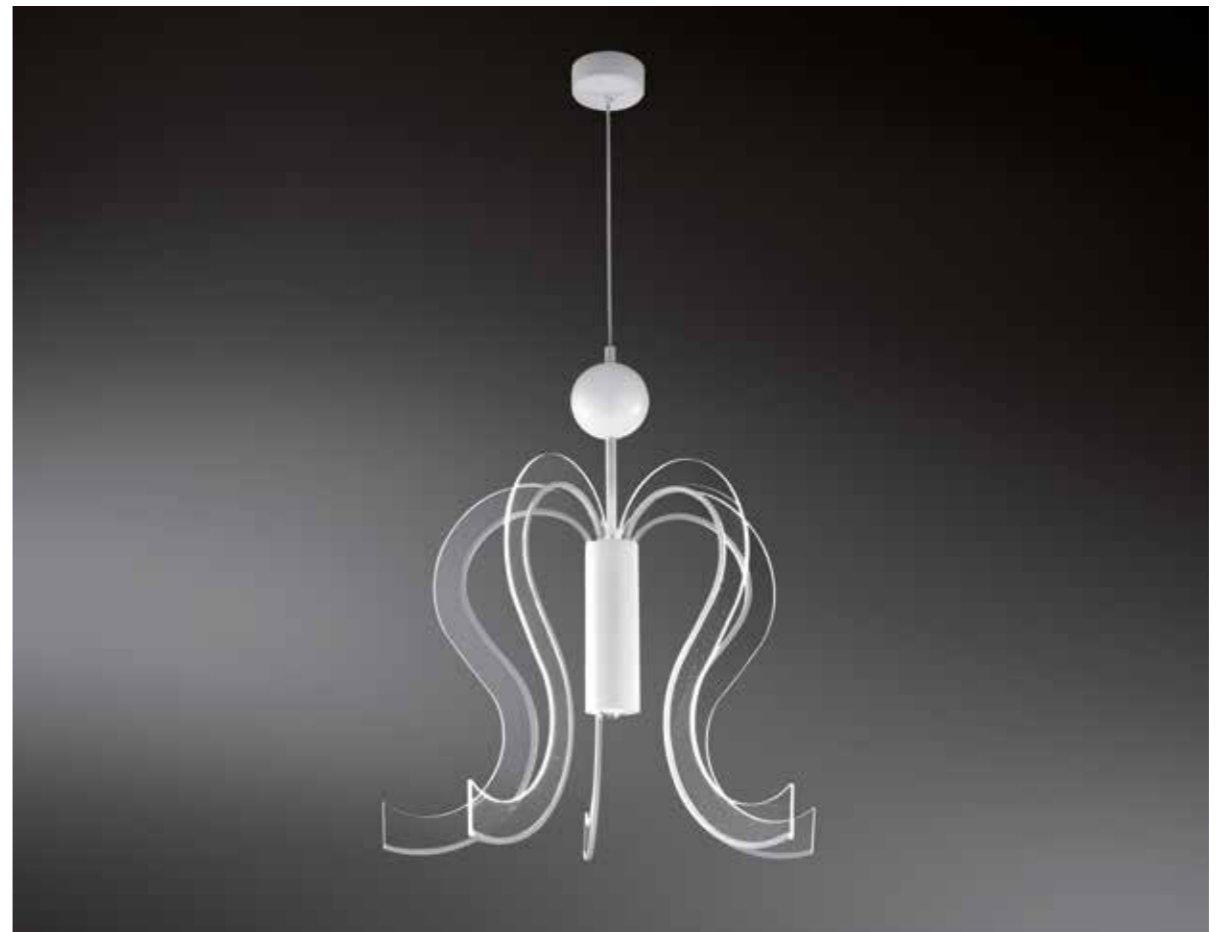

LED
03505
 57,6 + 6 W
 6300+880 Lumen

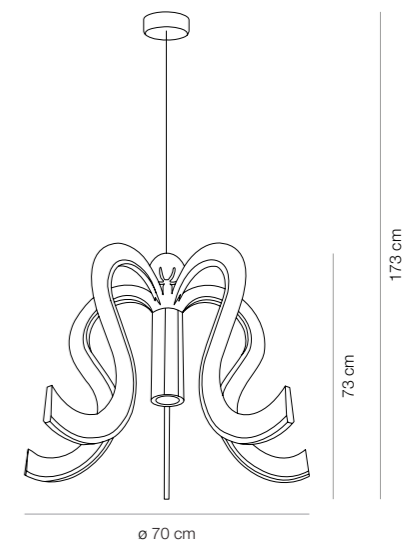

Struttura / Structure Structure / Struktur	Dimmer	Kelvin	Ottica / Lens Optique / Winkel	IP	Plexi
● BB	X Non previsto D Dimmer	H ● 2700K W ● 3000K N ● 4000K	X Non previsto	X IP20	XX

Versailles '18



LED
03506
 92+6 W
 10.000+880 Lumen

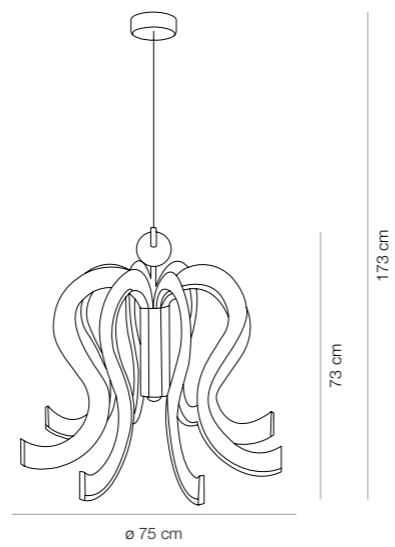

Struttura / Structure Structure / Struktur	Dimmer	Kelvin	Ottica / Lens Optique / Winkel	IP	Plexi
● BB	X Non previsto D Dimmer	H ● 2700K W ● 3000K N ● 4000K	X Non previsto	X IP20	XX

Versailles '18



Versailles '18



16

Versailles '18





17

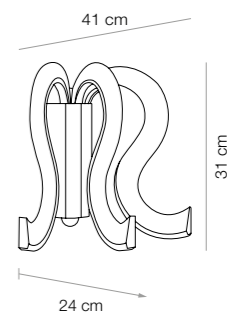

LED
03502
 17 + 3 W
 1.800+450 Lumen





Struttura / Structure Structure / Struktur	Dimmer	Kelvin	Ottica / Lens Optique / Winkel	IP	Plexi
● BB	X Non previsto D Dimmer	H ● 2700K W ● 3000K N ● 4000K	X Non previsto	X IP20	XX

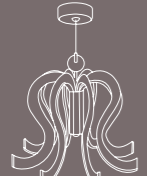



Versailles '18

Model	Code	Use	W	Lumen	Dimensions	Dimmer
	03505		57,6 + 6	6300+880	Ø 70 cm	X - D

Model	Code	Use	W	Lumen	Dimensions	Dimmer
	03506		92+6	10.000+880	Ø 75 cm	X - D

Model	Code	Use	W	Lumen	Dimensions	Dimmer
	03502		17 + 3	1.800+450	41 x 31 cm	X - D

Questo dispositivo è munito di lampade a LED integrate. Le lampade di questo dispositivo non sono sostituibili. Il trasformatore LED è incluso nella lampada. \ This luminaire contains built-in LED lamps. The lamps cannot be changed in the luminaire. LED trafo included in the lamp. \ Ce luminaire comporte des lampes à LED intégrées. Les lampes de ce luminaire ne peuvent pas être changées. LED trafo inclus dans la lamp. \ Diese Leuchte enthält eingebaute LED-Lampen. Die Lampen können in der Leuchten nicht ausgetauscht werden. LED Triber inklusiv in der Leuchte.

Struttura / Structure Structure / Struktur	Dimmer	Kelvin	Ottica / Lens Optique / Winkel	IP	Plexi
 BB	Vedi sopra See above Voir ci-dessus Siehe oben	H  2700K W  3000K N  4000K	X Non previsto	X IP20	XX

Designer



Versailles '18 è firmata da Paolo Francia, lighting designer dalle innovative conoscenze nel campo del design e della tecnica della luce. In Versailles '18 riecheggia il gusto del classico reinterpretato con grande originalità.

The Versailles '18 collection is the creation of Paolo Francia, a lighting designer with extensive experience in different areas. With his creativity and innovative knowledge in the field of design and lighting technique, his creations reflect tradition reinterpreted with great originality (as in the case of Versailles '18).

La collection Versailles '18 est le fruit de l'expérience de Paolo Francia, designer de luminaires d'une vaste compétence acquise dans différents domaines. Grâce à sa créativité et à son savoir-faire novateur en matière de conception et de technique de la lumière, Paolo réussit à réaliser des luminaires toujours inédits, comme dans le cas de Versailles '18, s'inspirant au classique réinterprété avec grande originalité.

Entworfen wurde Versailles '18 von Paolo Francia, einem Lichtplaner mit vielseitiger, langer Erfahrung. Dank seiner Kreativität und Kompetenz in Sachen Design und Lichttechnik gelingt es ihm immer wieder, mit originellen Entwürfen zu punkten: Im Falle von Versailles '18 besticht er mit einem Blick in die Vergangenheit, der gewusst wie neu interpretiert wird.

Air

Air è il perfetto connubio tra la potenza dei led COB e l'effetto illuminotecnico delle led strip di ultima generazione. Il diffusore in plexiglass è particolarmente luminoso grazie alla micro-puntinatura interna che permette una maggiore diffusione della luce.

The Air collection offers a perfect blend between the power of the COB LEDs and the subtle lighting effect of the latest generation LED strips. The Plexiglas shades enhance the beauty of the light and feature a stippled pattern which improves light diffusion, ensuring high luminosity.

La collection Air est le reflet de l'alliance parfaite entre la puissance des LED COB et la luminosité suggestive des rubans LED de dernière génération. À la recherche de matériaux en mesure d'exalter la beauté de la lumière, voici les diffuseurs en Plexiglas de grand effet et de grande luminosité, dont le micropointillage interne intensifie la diffusion de la lumière.

Die Serie Air repräsentiert das perfekte Zusammenspiel aus Leistung durch COB-LEDs und dem reizvollen Effekt von modernsten LED-Streifen. Auf der Suche nach einem Material, das die Schönheit von Licht so richtig in Szene zu setzen weiß, sind die Diffusoren aus Plexiglas entstanden: Mit ihrer mikrostrukturierten Oberfläche im Inneren sorgen sie für eine bessere Streuung des Lichts und erhöhen damit die Helligkeit der Leuchten.

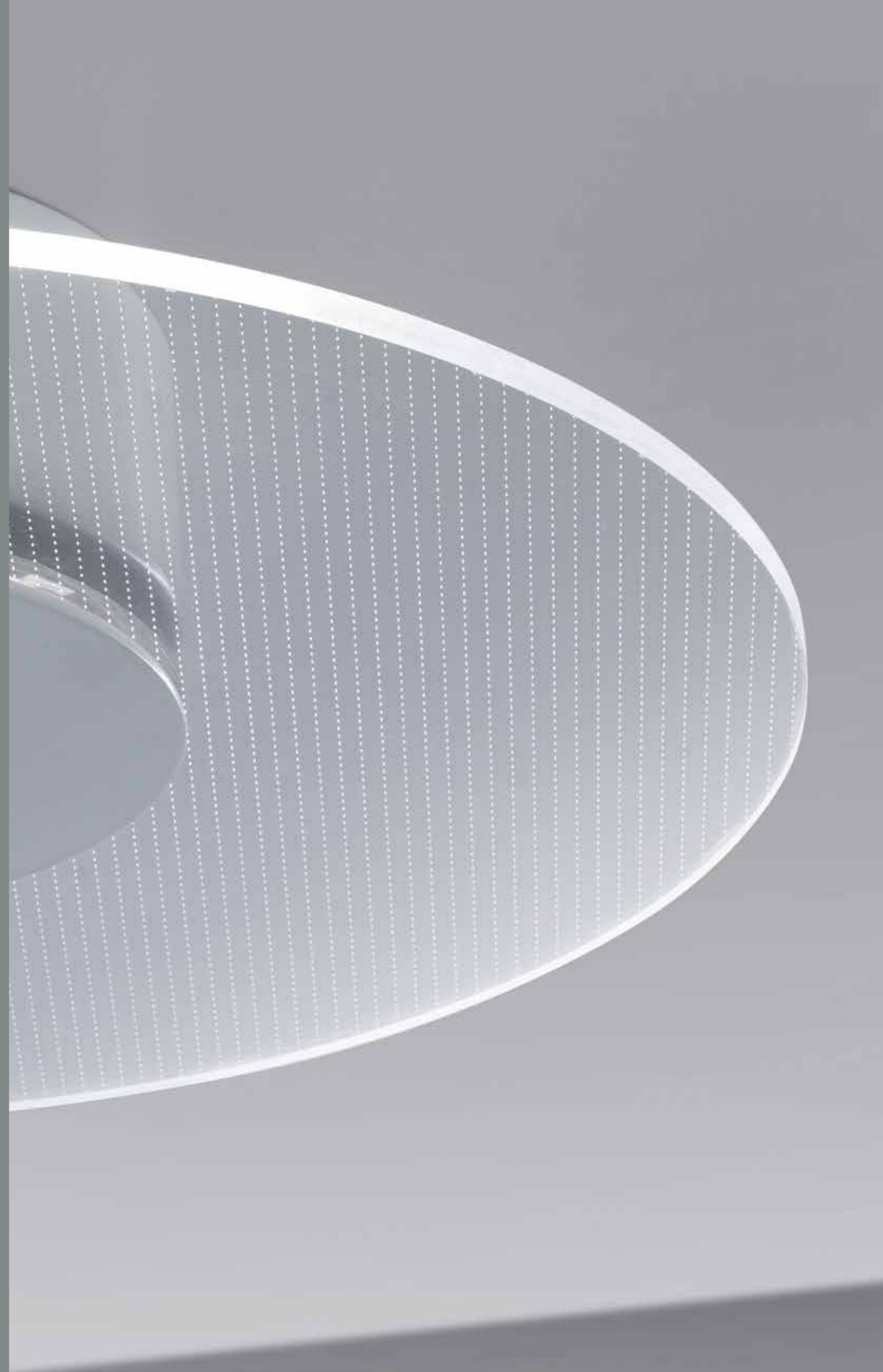



Air



LED
03408
6,3 W
800 Lumen

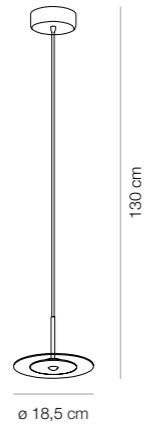

Air



LED
03410
20 W
2650 Lumen

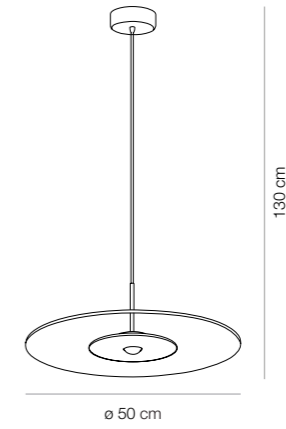

LED
03409
12 W
1400 Lumen

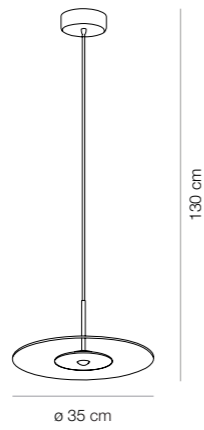

LED
03419
28 W
3850 Lumen

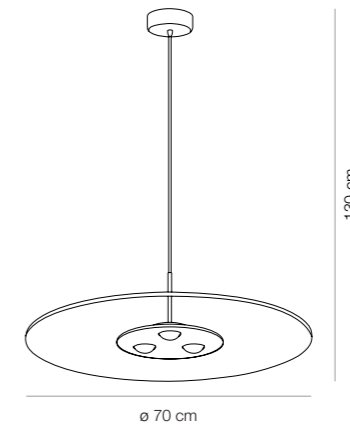

24

25

Struttura / Structure Structure / Struktur	Dimmer	Kelvin	Ottica / Lens Optique / Winkel	IP	Plexi
● AC	X Non previsto	H ● 2700K	X Non previsto	X IP20	XX
● OF	D Dimmer	W ● 3000K			
● BB		N ● 4000K			

Struttura / Structure Structure / Struktur	Dimmer	Kelvin	Ottica / Lens Optique / Winkel	IP	Plexi
● AC	D Dimmer	H ● 2700K	X Non previsto	X IP20	XX
● OF		W ● 3000K			
● BB		N ● 4000K			





LED
03425
37,8 W
4800 Lumen

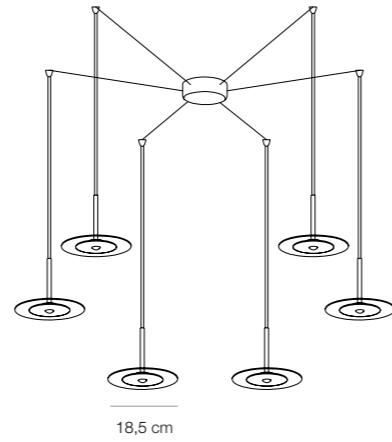

LED
03412
18,9 W
2400 Lumen

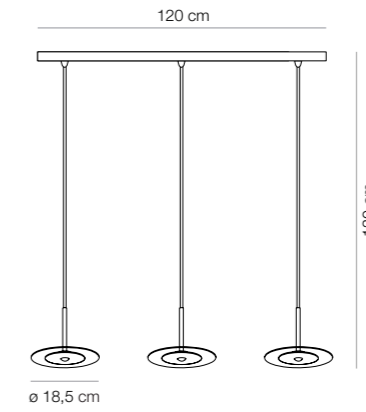

LED
03413
25,2 W
3200 Lumen

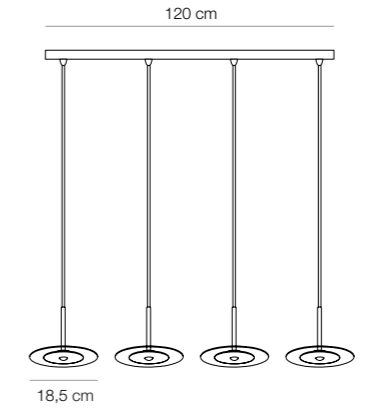

Personalizza la composizione di pendenti / Customize the hanging composition
Personnaliser la composition de suspension / Erstelle die Komposition von Hängeleuchte.

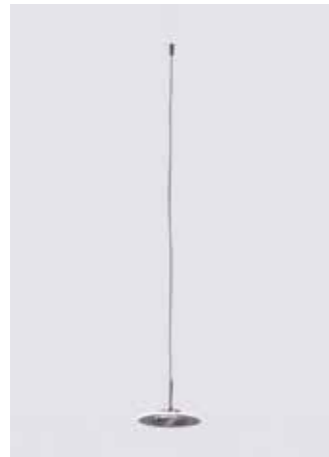

LED
03424
6,3 W
800 Lumen
Cavo/cable/câble/Kabel 250cm



Trasformatore incluso / driver included
/ trafo inclus / Treiber inclusiv.
03422
50W max 7 art. 03424
Ø 22,5 cm



Trasformatore incluso / driver included
/ trafo inclus / Treiber inclusiv.
03423
100W max 14 art. 03424
Ø 27 cm

Struttura / Structure Structure / Struktur	Dimmer	Kelvin	Ottica / Lens Optique / Winkel	IP	Plexi
● AC	X Non previsto	H ● 2700K	X Non previsto	X IP20	XX
● OF	A App iOS/Android	W ● 3000K			
● BB		N ● 4000K			

Struttura / Structure Structure / Struktur	Dimmer	Kelvin	Ottica / Lens Optique / Winkel	IP	Plexi
● AC	D Dimmer	H ● 2700K	X Non previsto	X IP20	XX
● OF		W ● 3000K			
● BB		N ● 4000K			



LED
03405
6,3 W
800 Lumen



LED
03406
12 W
1400 Lumen

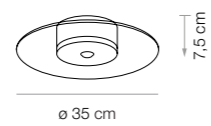

LED
03407
14,2 W
1800 Lumen

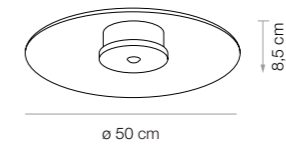

LED
03420
28 W
3850 Lumen

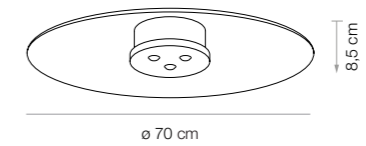

Struttura / Structure Structure / Struktur	Dimmer	Kelvin	Ottica / Lens Optique / Winkel	IP	Plexi
● AC	X Non previsto	H ● 2700K	X Non previsto	X IP20	XX
● OF	D Dimmer	W ● 3000K			
● BB		N ● 4000K			

Struttura / Structure Structure / Struktur	Dimmer	Kelvin	Ottica / Lens Optique / Winkel	IP	Plexi
● AC	D Dimmer	H ● 2700K	X Non previsto	X IP20	XX
● OF		W ● 3000K			
● BB		N ● 4000K			



LED
03401
2,2 W
250 Lumen

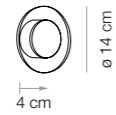

Struttura / Structure Structure / Struktur	Dimmer	Kelvin	Ottica / Lens Optique / Winkel	IP	Plexi
● AC	X Non previsto	H ● 2700K	X Non previsto	X IP20	XX
● OF		W ● 3000K			
● BB		N ● 4000K			

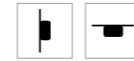

LED
03403
5,3 W
580 Lumen

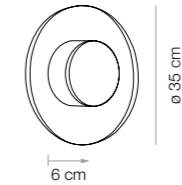

Struttura / Structure Structure / Struktur	Dimmer	Kelvin	Ottica / Lens Optique / Winkel	IP	Plexi
● AC	D Dimmer	H ● 2700K	X Non previsto	X IP20	XX
● OF		W ● 3000K			
● BB		N ● 4000K			



LED
03402
3,2 W
350 Lumen

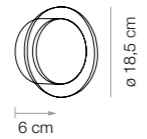

Struttura / Structure Structure / Struktur	Dimmer	Kelvin	Ottica / Lens Optique / Winkel	IP	Plexi
● AC	D Dimmer	H ● 2700K	X Non previsto	X IP20	XX
● OF		W ● 3000K			
● BB		N ● 4000K			



LED
03404
7,9 W
870 Lumen

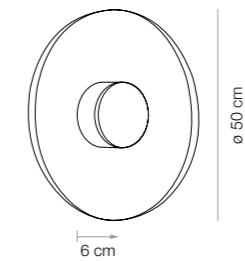

Struttura / Structure Structure / Struktur	Dimmer	Kelvin	Ottica / Lens Optique / Winkel	IP	Plexi
● AC	D Dimmer	H ● 2700K	X Non previsto	X IP20	XX
● OF		W ● 3000K			
● BB		N ● 4000K			

Air



LED
03414
 3,2 W
 350 Lumen

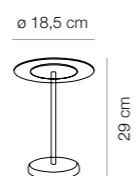

Struttura / Structure Structure / Struktur	Dimmer	Kelvin	Ottica / Lens Optique / Winkel	IP	Plexi
● AC	X Non previsto	H ● 2700K	X Non previsto	X IP20	XX
● OF	T Touch Dimmer	W ● 3000K			
● BB		N ● 4000K			

34



LED
03416
 49,5 W
 6600 Lumen

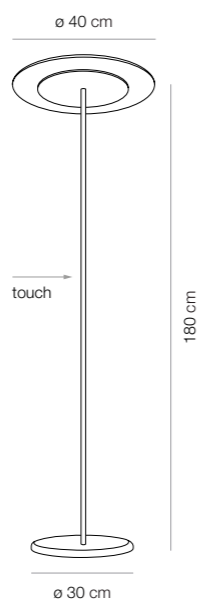

Struttura / Structure Structure / Struktur	Dimmer	Kelvin	Ottica / Lens Optique / Winkel	IP	Plexi
● AC	T Touch Dimmer	H ● 2700K	X Non previsto	X IP20	XX
● OF		W ● 3000K			
● BB		N ● 4000K			

Air



Kyte

Il potente led COB unito al suggestivo effetto creato dall'innovativo utilizzo dei led strip conferiscono alla Collezione Kyte moderna attualità. Questo risultato è ottenuto grazie all'uso come diffusore del plexiglass con micro-puntinatura interna che esalta la luminosità delle lampade.

The powerful COB LED combined with the subtle effect created by the innovative use of led strips give the Kyte Collection a cutting edge feel, thanks also to the innovative use of stippled Plexiglas which enhances the luminosity.

Particulièrement puissante et de grand effet, la LED COB en ruban confère une grande actualité à la collection Kyte et l'utilisation innovante du Plexiglas micropointillé exalte la luminosité des lampes.

Die leistungsstarke COB-LED und die Wirkung von innovativ verarbeiteten LED-Streifen verleihen der Serie Kyte eine zeitgemäße Dimension, die nicht zuletzt dem Einsatz von Plexiglas geschuldet ist, einem Material, das mit seiner mikrostrukturierten Oberfläche ein wesentlich helleres Licht schafft.







LED
03304
 13,3 W
 1700 Lumen

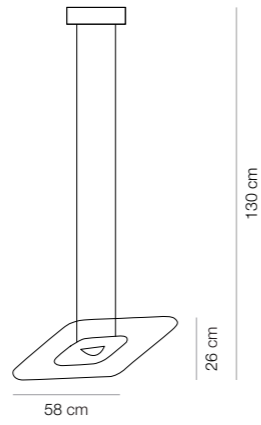

LED
03305
 34 W
 4100 Lumen

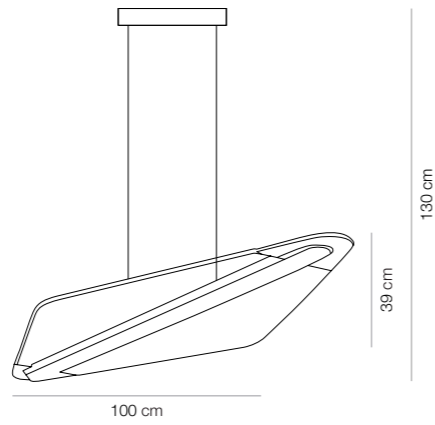

Struttura / Structure Structure / Struktur	Dimmer	Kelvin	Ottica / Lens Optique / Winkel	IP	Plexi
● AC	D Dimmer	H ● 2700K	X Non previsto	X IP20	XX
● OF		W ● 3000K			
● BB		N ● 4000K			



LED
03306
46 W
5600 Lumen

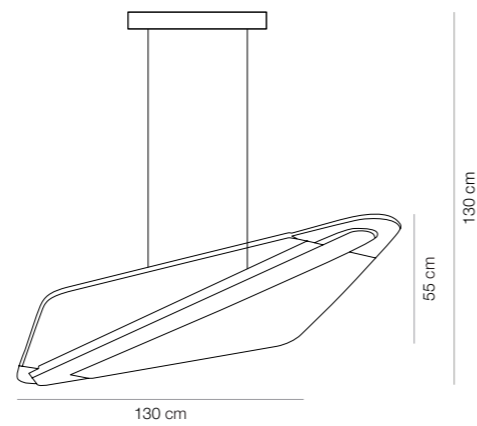

LED
03303
13,3 W
1700 Lumen

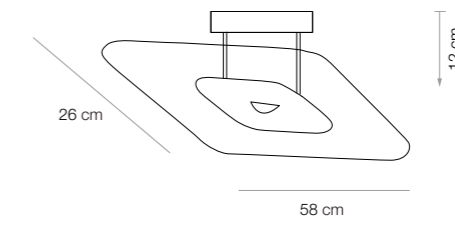

LED
03307
13,3 W
1700 Lumen



Struttura / Structure Structure / Struktur	Dimmer	Kelvin	Ottica / Lens Optique / Winkel	IP	Plexi
● AC	D Dimmer	H ● 2700K	X Non previsto	X IP20	XX
● OF		W ● 3000K			
● BB		N ● 4000K			

Struttura / Structure Structure / Struktur	Dimmer	Kelvin	Ottica / Lens Optique / Winkel	IP	Plexi
● AC	D Dimmer	H ● 2700K	X Non previsto	X IP20	XX
● OF		W ● 3000K			
● BB		N ● 4000K			

Kyte



LED
03301
6,5 W
700 Lumen

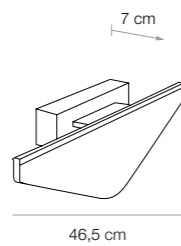

LED
03302
7 W
800 Lumen



Kyte

Model	Code	Use	W	Lumen	Dimensions	Dimmer
	03304		13,3	1700	58x26 cm / h 130 cm	D
	03305		34	4100	100x39 cm / h 130 cm	D
	03306		46	5600	130x55 cm / h 130 cm	D

Model	Code	Use	W	Lumen	Dimensions	Dimmer
	03303		13,3	1700	58x26 cm / h 12 cm	D
	03307		13,3	1700	58x26 cm / h 7 cm	D

Model	Code	Use	W	Lumen	Dimensions	Dimmer
	03301		6,5	700	L 46,5 cm	D
	03302		7	800	58x26 cm	D

Questo dispositivo è munito di lampade a LED integrate. Le lampade di questo dispositivo non sono sostituibili. Il trasformatore LED è incluso nella lampada. \ This luminaire contains built-in LED lamps. The lamps cannot be changed in the luminaire. LED trafo included in the lamp. \ Ce luminaire comporte des lampes à LED intégrées. Les lampes de ce luminaire ne peuvent pas être changées. LED trafo inclus dans la lamp. \ Diese Leuchte enthält eingebaute LED-Lampen. Die Lampen können in der Leuchten nicht ausgetauscht werden. LED Triber inklusiv in der Leuchte.

Struttura / Structure Structure / Struktur	Dimmer	Kelvin	Ottica / Lens Optique / Winkel	IP	Plexi
AC	D Dimmer	H 2700K	X Non previsto	X IP20	XX
OF		W 3000K			
BB		N 4000K			

Struttura / Structure Structure / Struktur	Dimmer	Kelvin	Ottica / Lens Optique / Winkel	IP	Plexi
AC	Vedi sopra See above Voir ci-dessus Siehe oben	H 2700K	X Non previsto	X IP20	XX
OF		W 3000K			
BB		N 4000K			

Rondaj

Il punto di forza della collezione Rondaj è l'utilizzo di LED COB integrati. Questo garantisce elevata efficienza e affidabilità. Sempre attenti alle esigenze illuminotecniche con la collezione Rondaj si vuole ampliare l'offerta di dispositivi LED a luce indiretta.

Strength of Rondaj collection is use of built-in LED COB. This assures high performance and reliability. Always careful to lighting requests, with Rondaj collection we want to expand the offer of LED devices with indirect light.

La force de la collection Rondaj est l'utilisation de la LED COB intégrée. Ça assure une haute efficacité et fiabilité. Toujours attentifs aux exigences de l'éclairagisme, avec la collection Rondaj on veut développer l'offre des articles avec la led à lumière indirecte.

Die Stärke der Kollektion Rondaj besteht im Einsatz von integrierten COB-LEDs. Diese gewährleisten eine hohe Effizienz und Zuverlässigkeit. Beleuchtungstechnische Erfordernisse immer im Blick habend weitet Elesi mit Rondaj das Angebot von LED-Leuchten für eine indirekte Beleuchtung aus.



Rondaj



50

Rondaj



LED
03605
 38 + 6 W
 5100 + 880 Lumen

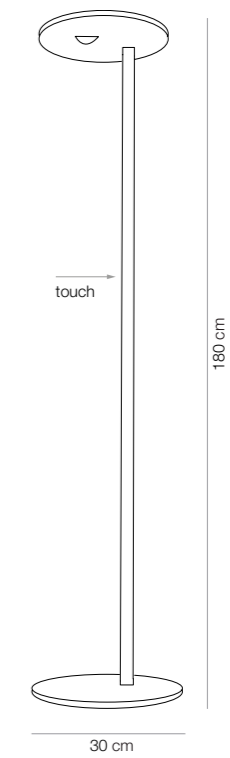

51

Struttura / Structure Structure / Struktur	Dimmer	Kelvin	Ottica / Lens Optique / Winkel	IP
● AC	T Touch Dimmer	H ● 2700K	X Non previsto	X IP20
● OF		W ● 3000K		
● BB		N ● 4000K		XX

Rondaj



LED
03604
38 W
5100 Lumen

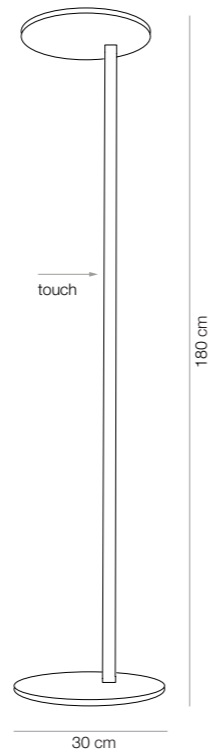

Rondaj



LED
03601
9 W
1400 Lumen

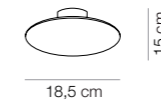

LED
03602
38 W
5200 Lumen

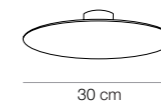

Struttura / Structure Structure / Struktur	Dimmer	Kelvin	Ottica / Lens Optique / Winkel	IP	
● AC	T Touch Dimmer	H ● 2700K	X Non previsto	X IP20	XX
● OF		W ● 3000K			
● BB		N ● 4000K			

Struttura / Structure Structure / Struktur	Dimmer	Kelvin	Ottica / Lens Optique / Winkel	IP	
● AC	D Dimmer	H ● 2700K	X Non previsto	X IP20	XX
● OF		W ● 3000K			
● BB		N ● 4000K			



Rondaj



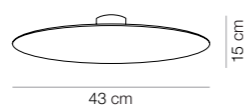



LED
03603
 50 W
 7200 Lumen













Rondaj

Model	Code	Use	W	Lumen	Dimensions	Dimmer
	03604		38	5100	Ø 30 cm / H 180 cm	T
	03605		38 + 6	5100 + 880	Ø 30 cm / H 180 cm	T

Model	Code	Use	W	Lumen	Dimensions	Dimmer
	03601		9	1400	Ø 18,5 cm / H 15 cm	D
	03602		38	5200	Ø 30 cm / H 15 cm	D
	03603		50	7200	Ø 43 cm / H 15 cm	D

Questo dispositivo è munito di lampade a LED integrate. Le lampade di questo dispositivo non sono sostituibili. Il trasformatore LED è incluso nella lampada. \ This luminaire contains built-in LED lamps. The lamps cannot be changed in the luminaire, LED trafo included in the lamp. \ Ce luminaire comporte des lampes à LED intégrées. Les lampes de ce luminaire ne peuvent pas être changées. LED trafo inclus dans la lamp. \ Diese Leuchte enthält eingebaute LED-Lampen. Die Lampen können in der Leuchten nicht ausgetauscht werden. LED Triber inklusiv in der Leuchte.

Struttura / Structure Structure / Struktur	Dimmer	Kelvin	Ottica / Lens Optique / Winkel	IP	
 AC	D Dimmer	H  2700K	X Non previsto	X IP20	XX
 OF		W  3000K			
 BB		N  4000K			

Struttura / Structure Structure / Struktur	Dimmer	Kelvin	Ottica / Lens Optique / Winkel	IP	Plexi
 AC	Vedi sopra See above Voir ci-dessus Siehe oben	H  2700K	X Non previsto	X IP20	XX
 OF		W  3000K			
 BB		N  4000K			

Imperium

Una linea di spot orientabili che si distingue per l'elevata efficienza luminosa. Ogni sorgente consuma 6 W e sviluppa 880 Lumen. Una performance assicurata dall'impiego di led COB di ultima generazione.

A traditional line of adjustable spotlights with a high luminous efficiency. Each source has a power consumption of 6W and emits 880 Lumen. A performance ensured by the use of the latest generation COB LEDs. All dimmerable.

Cette ligne traditionnelle de spots orientables se distingue par sa grande efficacité lumineuse. Chaque source consomme en effet 6 W et développe 880 lm. Une performance assurée par l'utilisation de LED COB de dernière génération. Tous les modèles sont dimmables.

Eine Serie von schwenkbaren Strahlern, die sich durch eine hohe Lichteffizienz auszeichnen. Jede Lichtquelle verbraucht nämlich nur 6 Watt und erzeugt 880 Lumen Lichtstrom. Erbracht wird diese Leistung durch den Verbau von innovativen COB-LEDs. Sämtliche Modelle sind dimmbar.



Imperium



Imperium

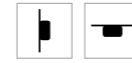

03103
18 W
2640 Lumen

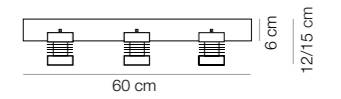

Struttura / Structure Structure / Struktur	Dimmer	Kelvin	Ottica / Lens Optique / Winkel	IP
● AC	D Dimmer	N ● 4000K		X IP20
● CR		W ● 3000K		P IP44
● OF				
● BB				

XX

Imperium



03101
6 W
880 Lumen

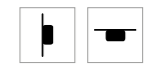
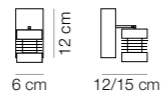

03102
12 W
1760 Lumen

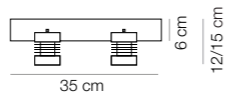

Imperium

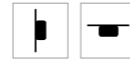

03104
24 W
3520 Lumen

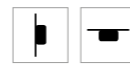
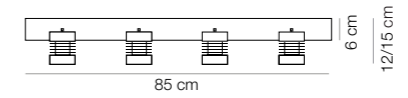

03105
30 W
4400 Lumen

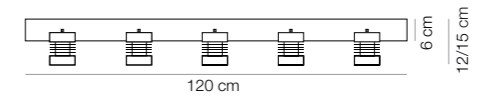

Struttura / Structure Structure / Struktur	Dimmer	Kelvin	Ottica / Lens Optique / Winkel	IP	
● AC	D Dimmer	N ● 4000K		X IP20	XX
● CR		W ● 3000K		P IP44	
● OF					
● BB					

Struttura / Structure Structure / Struktur	Dimmer	Kelvin	Ottica / Lens Optique / Winkel	IP	
● AC	D Dimmer	N ● 4000K		X IP20	XX
● CR		W ● 3000K		P IP44	
● OF					
● BB					

 **Elesi Luce**

ELESI LUCE srl
via Magellano, 8 35010 Trebaseleghe Padova ITALY
Tel +39 (0)49 9385235 - Fax +39 (0)49 9388689
info@elesiluce.it - www.elesiluce.it