

MORELIGHT

catalogue update

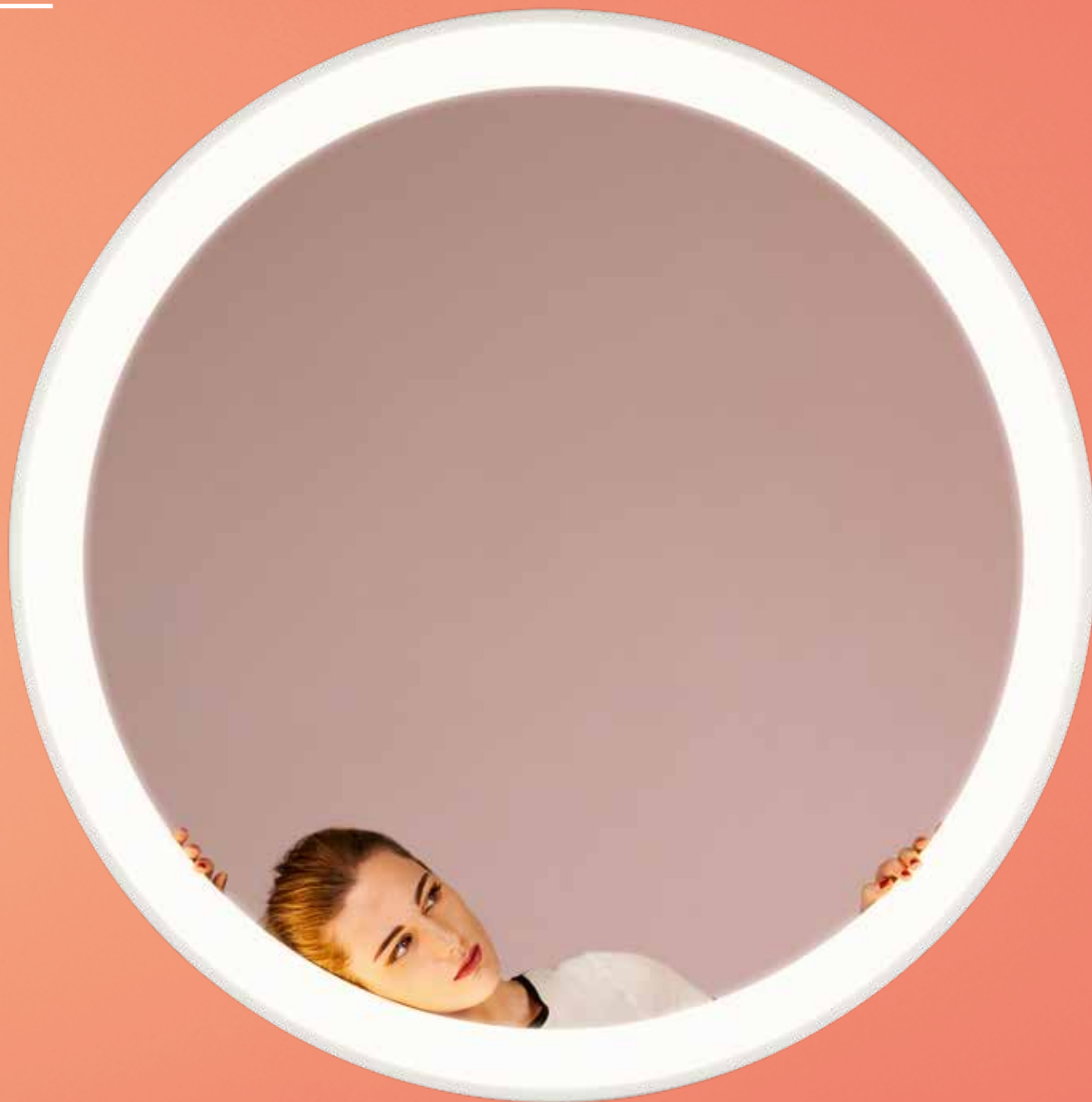

AFFRALUX

lighting experience

MORE IS MORE. PERCHÉ IL DESIGN NON HA LIMITI, COME L'IMMAGINAZIONE. E PENSA SEMPRE IN GRANDE. PERCHÈ DARE PIÙ SPAZIO ALLO STILE SIGNIFICA DARE PIÙ STILE A QUALSIASI SPAZIO. PERCHÈ LA LUCE PUÒ DARE SEMPLICEMENTE DI PIÙ. È TEMPO DI ESPANDERE LE PROPRIE PERCEZIONI. È TEMPO DI **MORE LIGHT.**

MORE IS MORE. BECAUSE DESIGN HAS NO LIMITS, LIKE THE IMAGINATION. AND ALWAYS THINKS BIG. BECAUSE GIVING MORE SPACE TO STYLE MEANS GIVING MORE STYLE TO ANY SPACE. BECAUSE LIGHT CAN SIMPLY GIVE MORE. IT'S TIME TO EXPAND OUR PERCEPTIONS. IT'S TIME FOR **MORE LIGHT.**

APRI LA MENTE

OPEN YOUR MIND

EXTRA-LARGE. LA COLLEZIONE BAND DIODI SI ARRICCHISCE DI UNA VARIANTE CON ANELLO DA 108 CM DI DIAMETRO. UNA GRANDE CORNICE PER RACCHIUDERE IL DESIDERIO INFINITO DI STILE.

EXTRA-LARGE. THE BAND DIODI COLLECTION IS ENHANCED WITH A RING VERSION, 108 CM IN DIAMETER. A LARGE FRAME FOR EMBRACING THE INFINITE DESIRE FOR STYLE.



EMOZIONATI

BE EXCITED



ESTETICA E LEGGEREZZA SONO I COMPAGNI DI GIOCO IDEALI DEL DESIGN. INSIEME CREANO EMOZIONE, SORPRESA. TRA GIOCHI DI FORMA, DI SPAZIO E DI LUCE.

AESTHETIC APPEAL AND LIGHTNESS ARE THE IDEAL PLAYMATES OF DESIGN. TOGETHER THEY LEAD TO EXCITEMENT AND SURPRISES. INTERPLAYS OF SHAPES, SPACE AND LIGHT.

PENSA IN LARGE

THINK LARGE

LARGE. LA RICERCA DI NUOVE DIMENSIONI DECORATIVE SI MANIFESTA ANCHE NELLA VARIANTE DA 80 CM DI DIAMETRO, SUGGERENDO ALLESTIMENTI CLUSTER IN GRADO DI ESPANDERE L'EFFETTO "LIBERTÀ".

LARGE. THE SEARCH FOR NEW DECORATIVE DIMENSIONS CAN ALSO BE SEEN IN THE VERSION 80 CM IN DIAMETER, PROMPTING CLUSTER COMPOSITIONS THAT CAN ENHANCE THE "FREEDOM" EFFECT.



VIVI LA TENDENZA

ENJOY THE TREND

PER LE COLLEZIONI BAND DIODI E ANELLI DIODI, LE NOVITÀ CONTINUANO CON LA NUOVA FINITURA SABBIA, SEMPRE PIÙ RICHIESTA DA CLIENTI E MERCATO. UNA TONALITÀ CHIC E ASSOLUTAMENTE MODERNA, CHE APRE A NUOVI ORIZZONTI ESPRESSIVI IN ABBINAMENTO CON GLI AMBIENTI.

FOR THE BAND DIODI AND ANELLI DIODI COLLECTIONS, THE NOVELTIES CONTINUE WITH THE NEW SAND FINISH, INCREASINGLY IN DEMAND BY CUSTOMERS AND THE MARKET. THIS CHIC MODERN COLOUR OPENS UP NEW EXPRESSIVE HORIZONS TO MATCH INTERIORS.



**NOI LA CHIAMIAMO:
L'ESPERIENZA AFFRALUX.
WE CALL IT: THE AFFRALUX EXPERIENCE**

Ci occupiamo di soluzioni per l'illuminazione. Lo facciamo con passione e abbiamo scelto di farlo al meglio. Siamo una struttura snella ma cresciamo veloci. E siamo veloci per rendere più leggera la vita dei nostri clienti. Crediamo nel cliente come risorsa e a lui dedichiamo quattro risorse per noi imprescindibili: materiali selezionati, affidabilità, costi competitivi e consegne più rapide di quanto si aspetti.

We work in the field of lighting solutions, dedicating much passion and choosing to do it in the best possible way. As a streamlined yet rapidly expanding company, we are quick to make life easier for our customers. We see our customers as a resource, dedicating four resources to them that are crucial to us: carefully selected materials, reliability, competitive prices and faster than expected deliveries.

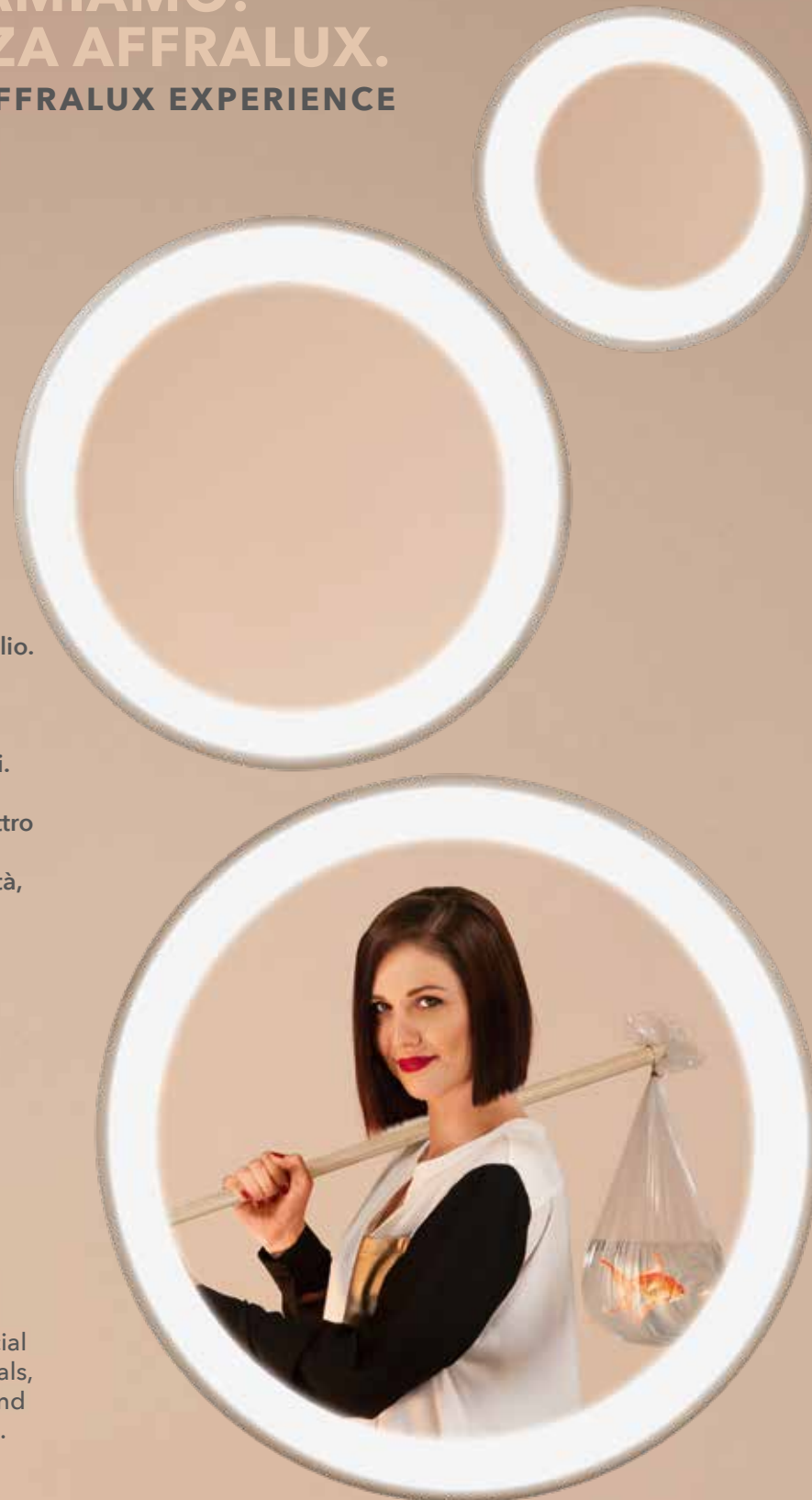

INDEX

010	BANDDIODI
026	ANELLIDIODI
038	ALURING
046	ACRYLED
052	QUATTRO
062	FLETSOSPENSIONI
068	FLETPLAFONIERE
074	BOL
080	BOLDIODI
086	TUBIDIODI Ø
088	TUBIDIODI ☒
090	PARABOLEDIODI
100	HEMIDARK
106	FRANGIA
120	ROTONDO
128	CRYSTALLIVS
134	NORA3

BANDDIODI

ALLUMINIO BIANCO / ALLUMINIO SABBIA
WHITE ALUMINUM / SAND ALUMINUM

_ Sospensioni e plafoniere con struttura in alluminio verniciato bianco o sabbia e finitura satinata. L'apparecchio è dotato di LED montati verso l'interno. Questi apparecchi sono dotati di LED con temperatura colore 3200K schermati da un diffusore in PMMA. La lunghezza dei cavi è regolabile.

_ Pendant and ceiling lamp with white or sand varnished aluminum frame and satin finish. These appliances are equipped with LED in 3200K colour temperature shielded by a PMMA light diffuser. The cable's length is adjustable.

2074S

sospensione Band Diodi extra-large
Band Diodi extra-large pendant lamp





2074S
sospensione Band Diodi extra-large
Band Diodi extra-large pendant lamp

2071S
sospensione Band Diodi grande
Band Diodi large pendant lamp

2070S
sospensione Band Diodi piccola
Band Diodi small pendant lamp

2049S
sospensione Band Diodi media
Band Diodi medium pendant lamp



2073S
 plafoniera Band Diodi piccola
 Band Diodi small ceiling lamp

2072S
 plafoniera Band Diodi media
 Band Diodi medium ceiling lamp

2076S
 plafoniera Band Diodi grande
 Band Diodi large ceiling lamp



2075S
 plafoniera Band Diodi extra-large
 Band Diodi extra-large ceiling lamp



2075S
plafoniera Band Diodi extra-large
Band Diodi extra-large ceiling lamp

2076S
plafoniera Band Diodi grande
Band Diodi large ceiling lamp

2072S
plafoniera Band Diodi media
Band Diodi medium ceiling lamp

2073S
plafoniera Band Diodi piccola
Band Diodi small ceiling lamp



2074
sospensione Band Diodi extra-large
Band Diodi extra-large pendant lamp



2049
sospensione Band Diodi media
Band Diodi medium pendant lamp



2071
sospensione Band Diodi grande
Band Diodi large pendant lamp



2070
sospensione Band Diodi piccola
Band Diodi small pendant lamp

2049
sospensione Band Diodi media
Band Diodi medium pendant lamp



2072
plafoniera Band Diodi media
Band Diodi medium ceiling lamp

2076
plafoniera Band Diodi grande
Band Diodi large ceiling lamp

2073
plafoniera Band Diodi piccola
Band Diodi small ceiling lamp

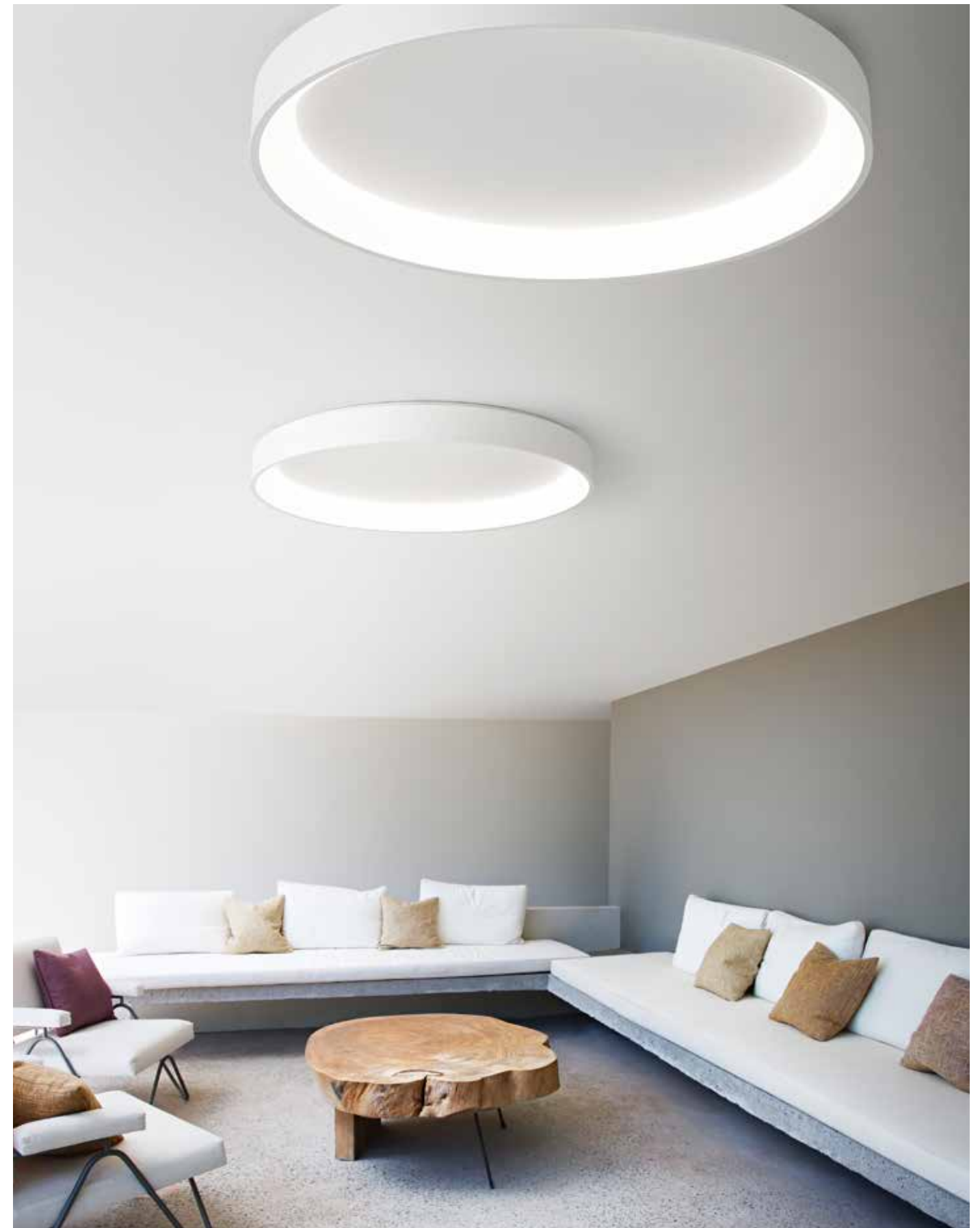

2075
plafoniera Band Diodi extra-large
Band Diodi extra-large ceiling lamp

BANDDIODI

ALLUMINIO BIANCO / ALLUMINIO SABBIA
WHITE ALUMINUM / SAND ALUMINUM

_ Sospensioni e plafoniere con struttura in alluminio verniciato bianco o sabbia e finitura satinata. L'apparecchio è dotato di LED montati verso l'interno. Questi apparecchi sono dotati di LED con temperatura colore 3200K schermati da un diffusore in PMMA. La lunghezza dei cavi è regolabile.

_ Pendant and ceiling lamp with white or sand varnished aluminum frame and satin finish. These appliances are equipped with LED in 3200K colour temperature shielded by a PMMA light diffuser. The cable's length is adjustable.



alluminio bianco
white aluminum



alluminio sabbia
sand aluminum

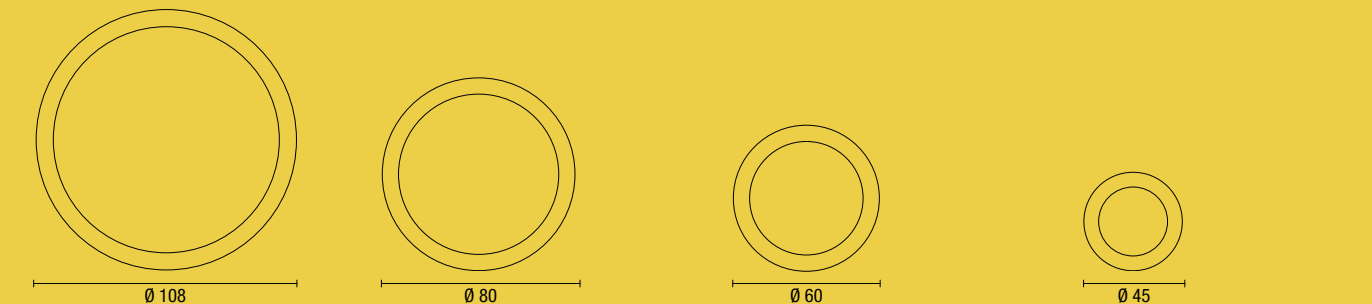
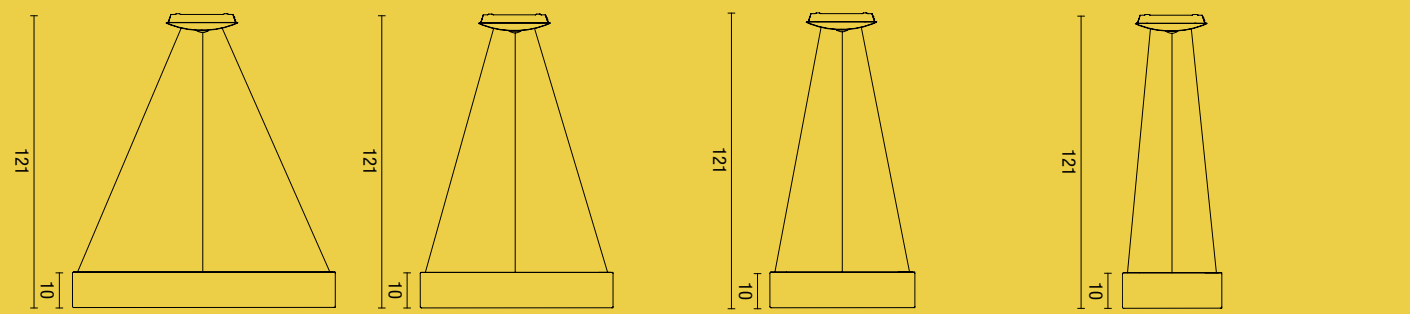

<p>sospensione Band Diodi extra-large Band Diodi extra-large pendant lamp</p> <p>bianco white 2074 sabbia sand 2074S</p>	<p>sospensione Band Diodi grande Band Diodi large pendant lamp</p> <p>bianco white 2071 sabbia sand 2071S</p>	<p>sospensione Band Diodi media Band Diodi medium pendant lamp</p> <p>bianco white 2049 sabbia sand 2049S</p>	<p>sospensione Band Diodi piccola Band Diodi small pendant lamp</p> <p>bianco white 2070 sabbia sand 2070S</p>
--	---	---	--

<p>lampadine lighting LED SMD 136W 3200K flusso luminoso luminous flux 8460 lm marca LED LED brand EPISTAR classe energetica energy class A</p>	<p>lampadine lighting LED SMD 90W 3200K flusso luminoso luminous flux 5600 lm marca LED LED brand EPISTAR classe energetica energy class A</p>	<p>lampadine lighting LED SMD 35W 3200K flusso luminoso luminous flux 2310 lm marca LED LED brand EPISTAR classe energetica energy class A</p>	<p>lampadine lighting LED SMD 25W 3200K flusso luminoso luminous flux 1630 lm marca LED LED brand EPISTAR classe energetica energy class A</p>
--	---	---	---

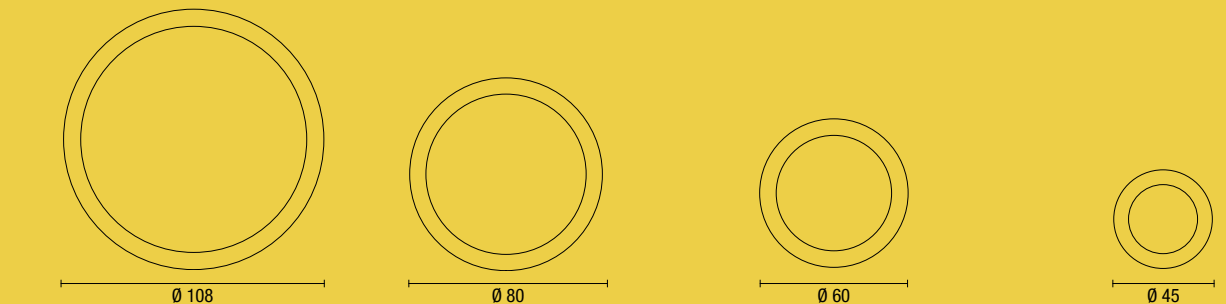

<p>plafoniera Band Diodi extra-large Band Diodi extra-large ceiling lamp</p> <p>bianco white 2075 sabbia sand 2075S</p>	<p>plafoniera Band Diodi grande Band Diodi large ceiling lamp</p> <p>bianco white 2076 sabbia sand 2076S</p>	<p>plafoniera Band Diodi media Band Diodi medium ceiling lamp</p> <p>bianco white 2072 sabbia sand 2072S</p>	<p>plafoniera Band Diodi piccola Band Diodi small ceiling lamp</p> <p>bianco white 2073 sabbia sand 2073S</p>
---	--	--	---

<p>lampadine lighting LED SMD 136W 3200K flusso luminoso luminous flux 8460 lm marca LED LED brand EPISTAR classe energetica energy class A</p>	<p>lampadine lighting LED SMD 90W 3200K flusso luminoso luminous flux 5600 lm marca LED LED brand EPISTAR classe energetica energy class A</p>	<p>lampadine lighting LED SMD 35W 3200K flusso luminoso luminous flux 2305 lm marca LED LED brand EPISTAR classe energetica energy class A</p>	<p>lampadine lighting LED SMD 25W 3200K flusso luminoso luminous flux 1630 lm marca LED LED brand EPISTAR classe energetica energy class A</p>
--	---	---	---



ANELLIDIODI

ALLUMINIO BIANCO / ALLUMINIO SABBIA
WHITE ALUMINUM / SAND ALUMINUM

_ Sospensione con struttura in alluminio verniciato bianco o sabbia e finitura satinata.

L'apparecchio è dotato di LED montati verso l'interno e la struttura è aperta sia verso il soffitto che verso il pavimento. Questi apparecchi sono dotati di LED con temperatura colore 3200K schermati da un diffusore in PMMA. La lunghezza dei cavi è regolabile.

_ Pendant lamp with white or sand varnished aluminum frame and satin finish. The lamp is equipped with LED 3200K colour and PMMA light diffuser mounted toward the inside and the structure is open on both sides. The cable's length is adjustable.



2052S
sospensione doppia Anelli Diodi grande
Anelli Diodi double pendant lamp large



2053S
sospensione doppia Anelli Diodi piccola
Anelli Diodi double pendant lamp small



2050S
sospensione Anelli Diodi
Anelli Diodi pendant lamp



2051S
sospensione Anelli Diodi tripla
Anelli Diodi triple pendant lamp



Esempio di applicazione con anelli regolabili a piacimento
Example of application with rings that can be adjusted as required



2051
sospensione Anelli Diodi tripla
Anelli Diodi triple pendant lamp





2053
sospensione doppia Anelli Diodi piccola
Anelli Diodi double pendant lamp small



2052
sospensione doppia Anelli Diodi grande
Anelli Diodi double pendant lamp large



2050
sospensione Anelli Diodi
Anelli Diodi pendant lamp

ANELLI DIODI

ALLUMINIO BIANCO / ALLUMINIO SABBIA
WHITE ALUMINUM / SAND ALUMINUM

_ Sospensione con struttura in alluminio verniciato bianco o sabbia e finitura satinata. L'apparecchio è dotato di LED montati verso l'interno e la struttura è aperta sia verso il soffitto che verso il pavimento. Questi apparecchi sono dotati di LED con temperatura colore 3200K schermati da un diffusore in PMMA. La lunghezza dei cavi è regolabile.

_ Pendant lamp with white or sand varnished aluminum frame and satin finish. The lamp is equipped with LED 3200K colour and PMMA light diffuser mounted toward the inside and the structure is open on both sides. The cable's length is adjustable.



alluminio bianco
white aluminum



alluminio sabbia
sand aluminum

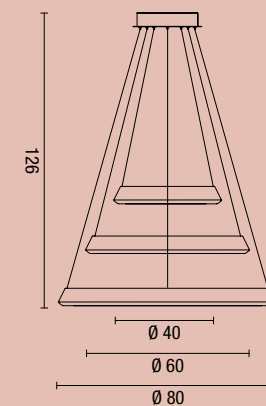

sospensione
Anelli Diodi tripla
Anelli Diodi triple
pendant lamp
bianco white **2051**
sabbia sand **2051S**

lampadine lighting
LED SMD 102W 3200K
flusso luminoso luminous flux
6160 lm
marca LED LED brand
EPISTAR
classe energetica energy class
A

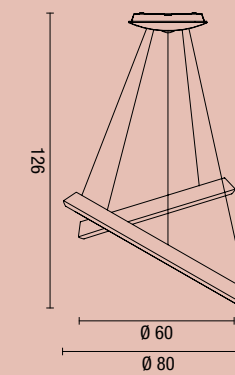

sospensione doppia
Anelli Diodi grande
Anelli Diodi double
pendant lamp large
bianco white **2052**
sabbia sand **2052S**

lampadine lighting
LED SMD 82W 3200K
flusso luminoso luminous flux
4970 lm
marca LED LED brand
EPISTAR
classe energetica energy class
A

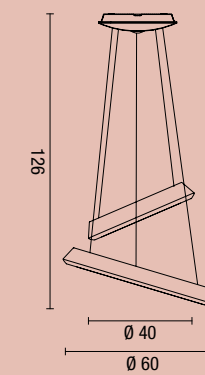

sospensione doppia
Anelli Diodi piccola
Anelli Diodi double
pendant lamp small
bianco white **2053**
sabbia sand **2053S**

lampadine lighting
LED SMD 54W 3200K
flusso luminoso luminous flux
3640 lm
marca LED LED brand
EPISTAR
classe energetica energy class
A

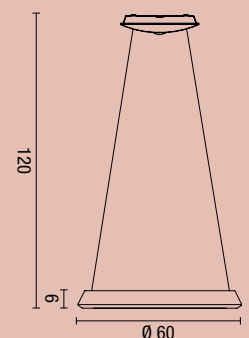

sospensione
Anelli Diodi
Anelli Diodi
pendant lamp
bianco white **2050**
sabbia sand **2050S**

lampadine lighting
LED SMD 35W 3200K
flusso luminoso luminous flux
2160 lm
marca LED LED brand
EPISTAR
classe energetica energy class
A



ALURING

ALLUMINIO BIANCO / WHITE ALUMINUM

_ Sospensione con struttura in alluminio verniciato bianco satinato; alloggiamento alimentatori in tinta. La lunghezza dei cavi è regolabile a piacimento.

_ Aluminum pendant lamp available in chrome finish with profile in white colour, satin finish; drivers' housing in same colour. Cables are adjustable at will.

2335

sospensione Aluring triplo anello
Aluring triple rings pendant lamp





2335
sospensione Aluring triplo anello
Aluring triple rings pendant lamp



2336
sospensione Aluring doppio anello
Aluring double rings pendant lamp



2334
sospensione rotonda Aluring grande
Aluring round pendant lamp large

2333
sospensione rotonda Aluring grande
Aluring round pendant lamp large



2332
sospensione quadrata Aluring grande
Aluring square pendant lamp large

2331
sospensione quadrata Aluring piccola
Aluring square pendant lamp small



2334
sospensione rotonda Aluring grande
Aluring round pendant lamp large

ALURING

ALLUMINIO BIANCO / WHITE ALUMINUM

_ Sospensione con struttura in alluminio verniciato bianco satinato; alloggiamento alimentatori in tinta.

La lunghezza dei cavi è regolabile a piacimento.

_ Aluminum pendant lamp available in chrome finish with profile in white colour, satin finish; drivers' housing in same colour. Cables are adjustable at will.

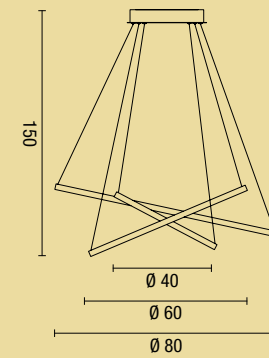

sospensione Aluring
triplo anello
Aluring triple rings
pendant lamp

2335

lampadine
lighting

STRIP LED 71W 3200K

flusso luminoso
luminous flux

4970 lm

marca LED
LED brand

EPISTAR

classe energetica
energy class

A



CE

IP20

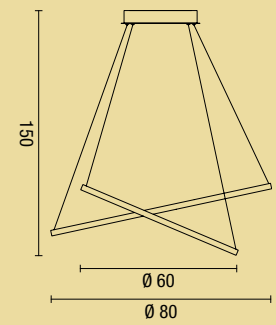

sospensione Aluring
doppio anello
Aluring double rings
pendant lamp

2336

lampadine
lighting

STRIP LED 58W 3200K

flusso luminoso
luminous flux

4060 lm

marca LED
LED brand

EPISTAR

classe energetica
energy class

A



CE

IP20

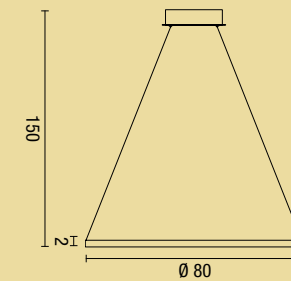

sospensione rotonda
Aluring grande
Aluring round
pendant lamp large

2334

lampadine
lighting

STRIP LED 32W 3200K

flusso luminoso
luminous flux

2240 lm

marca LED
LED brand

EPISTAR

classe energetica
energy class

A



CE

IP20

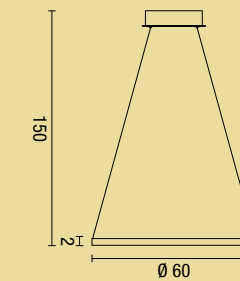

sospensione rotonda
Aluring piccola
Aluring round
pendant lamp small

2333

lampadine
lighting

STRIP LED 26W 3200K

flusso luminoso
luminous flux

1820 lm

marca LED
LED brand

EPISTAR

classe energetica
energy class

A



CE

IP20

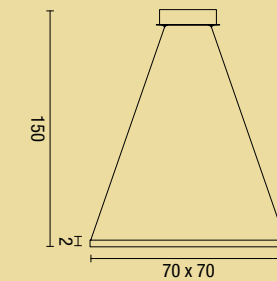

sospensione quadrata
Aluring grande
Aluring square
pendant lamp large

2332

lampadine
lighting

STRIP LED 33W 3200K

flusso luminoso
luminous flux

2310 lm

marca LED
LED brand

EPISTAR

classe energetica
energy class

A



CE

IP20

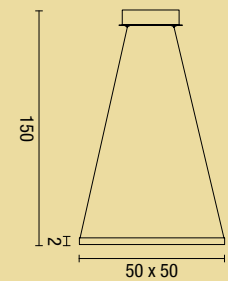

sospensione quadrata
Aluring piccola
Aluring square
pendant lamp small

2331

lampadine
lighting

STRIP LED 28W 3200K

flusso luminoso
luminous flux

1960 lm

marca LED
LED brand

EPISTAR

classe energetica
energy class

A



CE

IP20

ACRYLED

DIFFUSORI IN ACRILICO / ACRYLIC LIGHT DIFFUSER

_ La struttura è metallo verniciato con finitura satinata sulla quale sono montati elementi in materiale acrilico che svolgono la funzione di diffusori. Le versioni singole sono disponibili in tre misure. Due versioni della sospensione doppia completano questa serie: una versione composta da anello piccolo e medio e l'altra composta da anello medio e grande.

_ The structure is painted metal with satin finish with elements in acrylic material acting as light diffusers. The single versions are available in three sizes. Two versions of the double ring complete this serie: one is made with small and medium sizes, while the other has the medium with the large size.



2308
sospensione Acryled anello grande
Acryled ring large pendant lamp

2305
sospensione Acryled anello piccolo
pendant lamp Acryled ring small



2308
sospensione Acryled anello grande
Acryled ring large pendant lamp



2305
sospensione Acryled anello piccolo
pendant lamp Acryled ring small

2306
sospensione Acryled anello medio
pendant lamp Acryled ring medium



2304
sospensione doppio anello Acryled grande
Acryled double ring pendant lamp large

ACRYLED

DIFFUSORI IN ACRILICO / ACRYLIC LIGHT DIFFUSER

_ La struttura è metallo verniciato con finitura satinata sulla quale sono montati elementi in materiale acrilico che svolgono la funzione di diffusori. Le versioni singole sono disponibili in tre misure. Due versioni della sospensione doppia completano questa serie: una versione composta da anello piccolo e medio e l'altra composta da anello medio e grande.

_ The structure is painted metal with satin finish with elements in acrylic material acting as light diffusers. The single versions are available in three sizes. Two versions of the double ring complete this serie: one is made with small and medium sizes, while the other has the medium with the large size.

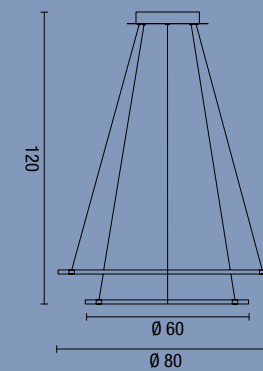

sospensione doppio anello Acryled grande
Acryled double ring pendant lamp large

2304

lampadine lighting

STRIP LED 53W 3000K

flusso luminoso luminous flux

3710 lm

marca LED LED brand

EPISTAR

classe energetica energy class

A



CE
IP20

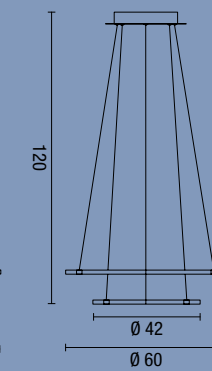

sospensione doppio anello Acryled piccola
Acryled double ring pendant lamp small

2307

lampadine lighting

STRIP LED 36W 3000K

flusso luminoso luminous flux

2520 lm

marca LED LED brand

EPISTAR

classe energetica energy class

A



CE
IP20

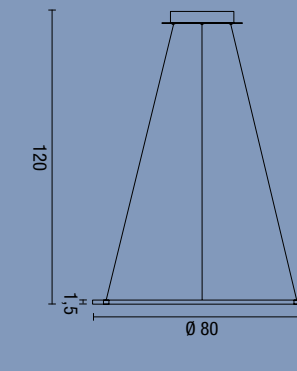

sospensione Acryled anello grande
Acryled ring large pendant lamp

2308

lampadine lighting

STRIP LED 32W 3000K

flusso luminoso luminous flux

2240 lm

marca LED LED brand

EPISTAR

classe energetica energy class

A



CE
IP20

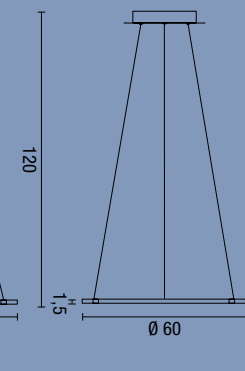

sospensione Acryled anello medio
pendant lamp Acryled ring medium

2306

lampadine lighting

STRIP LED 23W 3000K

flusso luminoso luminous flux

1610 lm

marca LED LED brand

EPISTAR

classe energetica energy class

A



CE
IP20

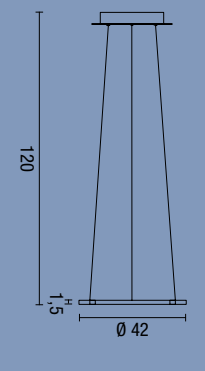

sospensione Acryled anello piccolo
pendant lamp Acryled ring small

2305

lampadine lighting

STRIP LED 14W 3000K

flusso luminoso luminous flux

980 lm

marca LED LED brand

EPISTAR

classe energetica energy class

A



CE
IP20

QUATTRO

PROFILI IN ALLUMINIO BIANCO / WHITE ALUMINUM PROFILES

_ Sospensioni con profili in alluminio verniciato bianco e finitura sabbata. Gli apparecchi sono dotati di LED SMD, temperatura colore 3000K, con diffusore di protezione in silicone. La lunghezza dei cavi è regolabile.

_ Pendant lamps with white varnished aluminum profiles and sanded finish. These lamps are equipped with SMD LED PCB in 3000K colour temperature shielded by silicon light diffuser. Cables' length is adjustable.

2343

sospensione Quattro grande
Quattro large pendant lamp





2343
sospensione Quattro grande
Quattro large pendant lamp



2341
sospensione Quattro piccola
Quattro small pendant lamp



2340
sospensione quadrata Quattro
pendant lamp Quattro square



2344
plafoniera Quattro
Quattro ceiling lamp

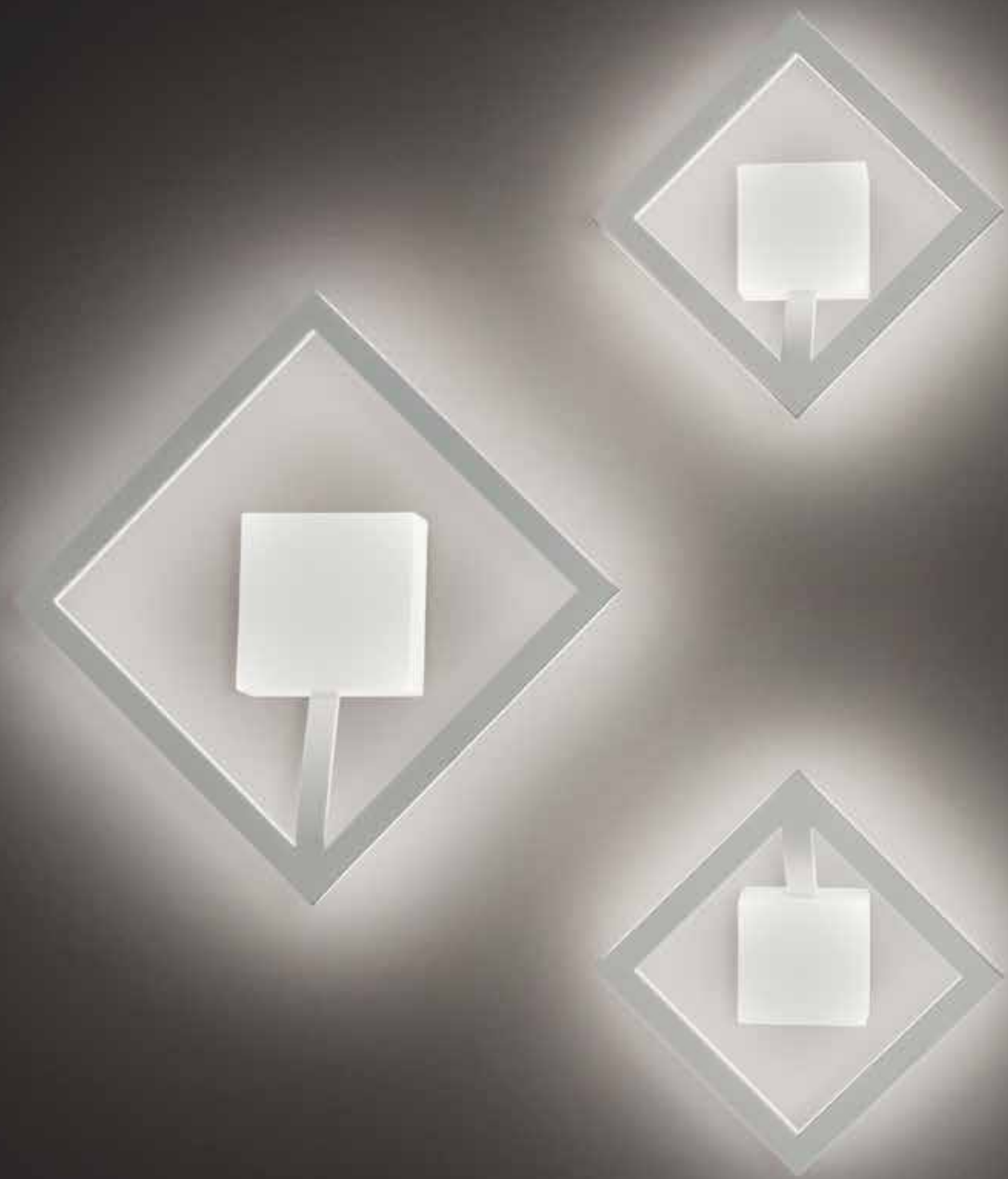

2345
plafoniera/applique Quattro grande
Quattro large ceiling/wall lamp

2346
plafoniera/applique Quattro piccola
Quattro small ceiling/wall lamp



2346
plafoniera/applique Quattro piccola
Quattro small ceiling/wall lamp

QUATTRO

PROFILI IN ALLUMINIO BIANCO / WHITE ALUMINUM PROFILES

_ Sospensioni con profili in alluminio verniciato bianco e finitura sabbata. Gli apparecchi sono dotati di LED SMD, temperatura colore 3000K, con diffusore di protezione in silicone. La lunghezza dei cavi è regolabile.

_ Pendant lamps with white varnished aluminum profiles and sanded finish. These lamps are equipped with SMD LED PCB in 3000K colour temperature shielded by silicon light diffuser. Cables' length is adjustable.

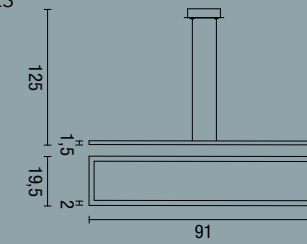

sospensione
Quattro grande
Quattro large
pendant lamp

2343

lampadine
lighting

LED SDM 80W 3000K

flusso luminoso
luminous flux

9600 lm

marca LED
LED brand

EPISTAR

classe energetica
energy class

A



CE

IP20

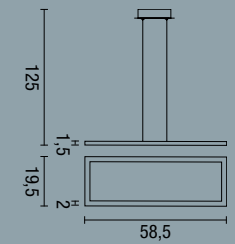

sospensione
Quattro piccola
Quattro small
pendant lamp

2341

lampadine
lighting

LED SDM 56W 3000K

flusso luminoso
luminous flux

6720 lm

marca LED
LED brand

EPISTAR

classe energetica
energy class

A



CE

IP20

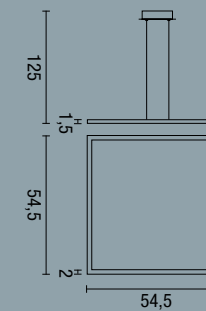

sospensione
quadrata Quattro
pendant lamp
Quattro square

2340

lampadine
lighting

LED SDM 80W 3000K

flusso luminoso
luminous flux

9600 lm

marca LED
LED brand

EPISTAR

classe energetica
energy class

A



CE

IP20

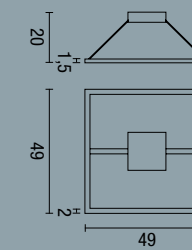

plafoniera Quattro
Quattro ceiling lamp

2344

lampadine
lighting

LED SDM 72W 3000K

flusso luminoso
luminous flux

8640 lm

marca LED
LED brand

EPISTAR

classe energetica
energy class

A



CE

IP20

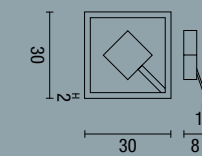

plafoniera/applique
Quattro grande
Quattro large
ceiling/wall lamp

2345

lampadine
lighting

LED SDM 40W 3000K

flusso luminoso
luminous flux

4800 lm

marca LED
LED brand

EPISTAR

classe energetica
energy class

A



CE

IP20

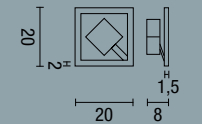

plafoniera/applique
Quattro piccola
Quattro small
ceiling/wall lamp

2346

lampadine
lighting

LED SDM 24W 3000K

flusso luminoso
luminous flux

2880 lm

marca LED
LED brand

EPISTAR

classe energetica
energy class

A



CE

IP20



FLETSOSPENSIONI

ALLUMINIO BIANCO / WHITE ALUMINUM

_ Sospensioni in alluminio verniciato bianco con finitura sabbata.

Attacco per lampadine GX53 LED; le lampadine non sono fornite, ma l'apparecchio è compatibile con lampade di classe energetica dalla A alla A++.

La lunghezza dei cavi è regolabile.

_ Pendant lamp in aluminum with white colour sanded finish. Lamp socket is GX53 LED; light bulbs are not included, but the appliance is compatible with A to A++ energy class lightbulbs. The cables' length is adjustable.

2077P

sospensione Flet 4 luci + 1 luce verso soffitto
Flet pendant lamp with 4 lights + 1 light towards ceiling





2077G
sospensione Flet 8 luci + 2 luci verso soffitto
Flet pendant lamp with 8 lights + 2 lights towards ceiling

2077P
sospensione Flet 4 luci + 1 luci verso soffitto
Flet pendant lamp with 4 lights + 1 light towards ceiling



2079G
sospensione Flet rettangolare 6 luci + 1 luce verso soffitto
Flet rectangular pendant lamp with 6 lights + 1 light towards ceiling

2079P
sospensione Flet rettangolare 2 luci + 1 luce verso soffitto
Flet rectangular pendant lamp with 2 lights + 1 light towards ceiling



2079X

sospensione Flet rettangolare 8 luci + 2 luci verso soffitto
Flet rectangular pendant lamp with 8 lights + 2 lights towards ceiling

FLETSOSPENSIONI

ALLUMINIO BIANCO / WHITE ALUMINUM

_ Sospensioni in alluminio verniciato bianco con finitura sabbata.

Attacco per lampadine GX53 LED; le lampadine non sono fornite, ma l'apparecchio è compatibile con lampade di classe energetica dalla A alla A++.

La lunghezza dei cavi è regolabile.

_ Pendant lamp in aluminum with white colour sanded finish. Lamp socket is GX53 LED; light bulbs are not included, but the appliance is compatible with A to A++ energy class lightbulbs. The cables' length is adjustable.

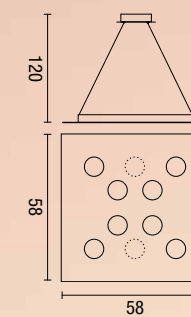
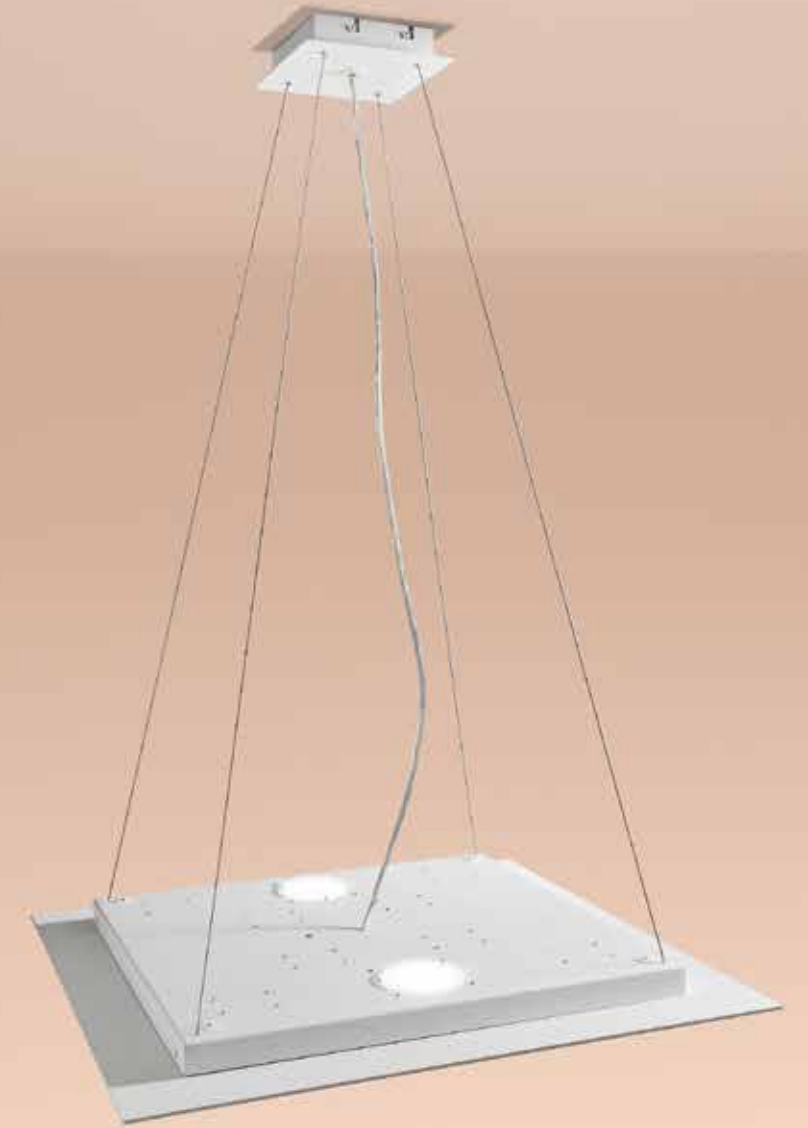

sospensione Flet 8 luci
+ 2 luci verso soffitto
Flet pendant lamp
with 8 lights + 2 lights
towards ceiling

2077G

lampadine
lighting

10 x GX53 LED ⚡

classe energetica
energy class

A/A++

lampadine non include
bulbs not included

CE
IP20

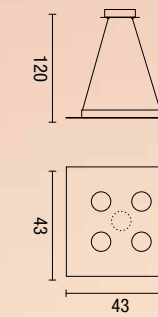

sospensione Flet 4 luci
+ 1 luce verso soffitto
Flet pendant lamp
with 4 lights + 1 light
towards ceiling

2077P

lampadine
lighting

5 x GX53 LED ⚡

classe energetica
energy class

A/A++

lampadine non include
bulbs not included

CE
IP20

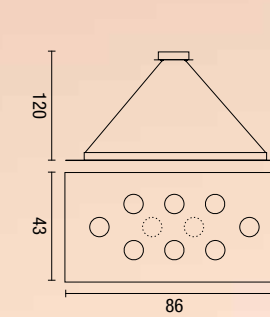

sospensione Flet
rettangolare 8 luci
+ 2 luci verso soffitto
Flet rectangular
pendant lamp with 8 lights
+ 2 lights towards ceiling

2079X

lampadine
lighting

10 x GX53 LED ⚡

classe energetica
energy class

A/A++

lampadine non include
bulbs not included

CE
IP20

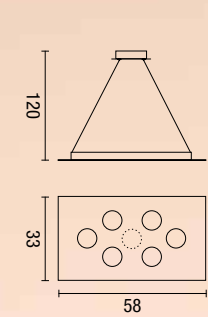

sospensione Flet
rettangolare 6 luci
+ 1 luce verso soffitto
Flet rectangular
pendant lamp with 6 lights
+ 1 light towards ceiling

2079G

lampadine
lighting

7 x GX53 LED ⚡

classe energetica
energy class

A/A++

lampadine non include
bulbs not included

CE
IP20

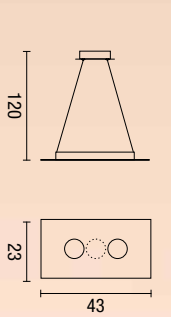

sospensione Flet
rettangolare 2 luci
+ 1 luce verso soffitto
Flet rectangular
pendant lamp with 2 lights
+ 1 light towards ceiling

2079P

lampadine
lighting

3 x GX53 LED ⚡

classe energetica
energy class

A/A++

lampadine non include
bulbs not included

CE
IP20



FLETPLAFONIERE

ALLUMINIO BIANCO / WHITE ALUMINUM

_ Plafoniere in alluminio verniciato bianco con finitura sabbata.

Attacco per lampadine GX53 LED; le lampadine non sono fornite, ma l'apparecchio è compatibile con lampade di classe energetica dalla A alla A++.

La lunghezza dei cavi è regolabile.

_ Ceiling lamps in aluminum with white colour sanded finish. Lamp socket is GX53 LED; light bulbs are not included, but the appliance is compatible with A to A++ energy class lightbulbs. The cables' length is adjustable.

2080X

plafoniera Flet rettangolare 8 luci
Flet rectangular ceiling lamp with 8 lights





2080G
plafoniera Flet rettangolare 6 luci
Flet rectangular ceiling lamp with 6 lights



2080P
plafoniera Flet rettangolare 2 luci
Flet rectangular ceiling lamp with 2 lights



2078
plafoniera Flet 1 luce
Flet ceiling lamp with 1 light



2078P
plafoniera Flet 4 luci
Flet ceiling lamp with 4 lights

2078G
plafoniera Flet 8 luci
Flet ceiling lamp with 8 lights

FLETPLAFONIERE

ALLUMINIO BIANCO / WHITE ALUMINUM

_ Plafoniere in alluminio verniciato bianco con finitura sabbata.

Attacco per lampadine GX53 LED; le lampadine non sono fornite, ma l'apparecchio è compatibile con lampade di classe energetica dalla A alla A++.

La lunghezza dei cavi è regolabile.

_ Ceiling lamps in aluminum with white colour sanded finish. Lamp socket is GX53 LED; light bulbs are not included, but the appliance is compatible with A to A++ energy class lightbulbs. The cables' length is adjustable.

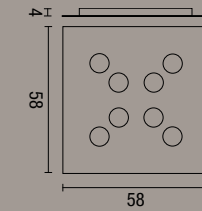

plafoniera Flet
8 luci
Flet ceiling lamp
with 8 lights

2078G

lampadine
lighting

8 x GX53 LED ⚡

classe energetica
energy class

A/A++

lampadine non include
bulbs not included

CE
IP20

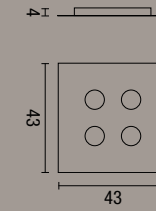

plafoniera Flet
4 luci
Flet ceiling lamp
with 4 lights

2078P

lampadine
lighting

4 x GX53 LED ⚡

classe energetica
energy class

A/A++

lampadine non include
bulbs not included

CE
IP20

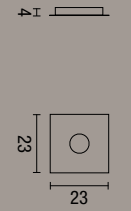

plafoniera Flet
1 luce
Flet ceiling lamp
with 1 light

2078

lampadine
lighting

1 x GX53 LED ⚡

classe energetica
energy class

A/A++

lampadine non include
bulbs not included

CE
IP20

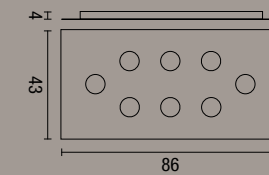

plafoniera Flet
rettangolare
8 luci
Flet rectangular
ceiling lamp
with 8 lights

2080X

lampadine
lighting

8 x GX53 LED ⚡

classe energetica
energy class

A/A++

lampadine non include
bulbs not included

CE
IP20

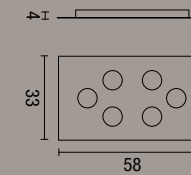

plafoniera Flet
rettangolare
6 luci
Flet rectangular
ceiling lamp
with 6 lights

2080G

lampadine
lighting

6 x GX53 LED ⚡

classe energetica
energy class

A/A++

lampadine non include
bulbs not included

CE
IP20

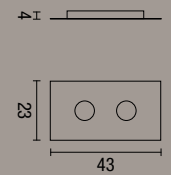

plafoniera Flet
rettangolare
2 luci
Flet rectangular
ceiling lamp
with 2 lights

2080P

lampadine
lighting

2 x GX53 LED ⚡

classe energetica
energy class

A/A++

lampadine non include
bulbs not included

CE
IP20

BOL

SFERE CROMATE / CHROMEPLATED SPHERES

_ Sospensione con struttura in metallo cromato e finitura a specchio. I pendenti possono essere regolati all'altezza desiderata. Lampadine non incluse, ma l'apparecchio è compatibile con lampadine di classe energetica dalla E alla A++.

_ Pendant lamp with chromed metal frame and mirror finish. The pendants can be adjustable to the desired height. Bulbs are not included, but the unit is compatible with bulbs of the energy class from E to A++.

2314

sospensione Bol 6 luci
Bol pendant lamp 6 lights

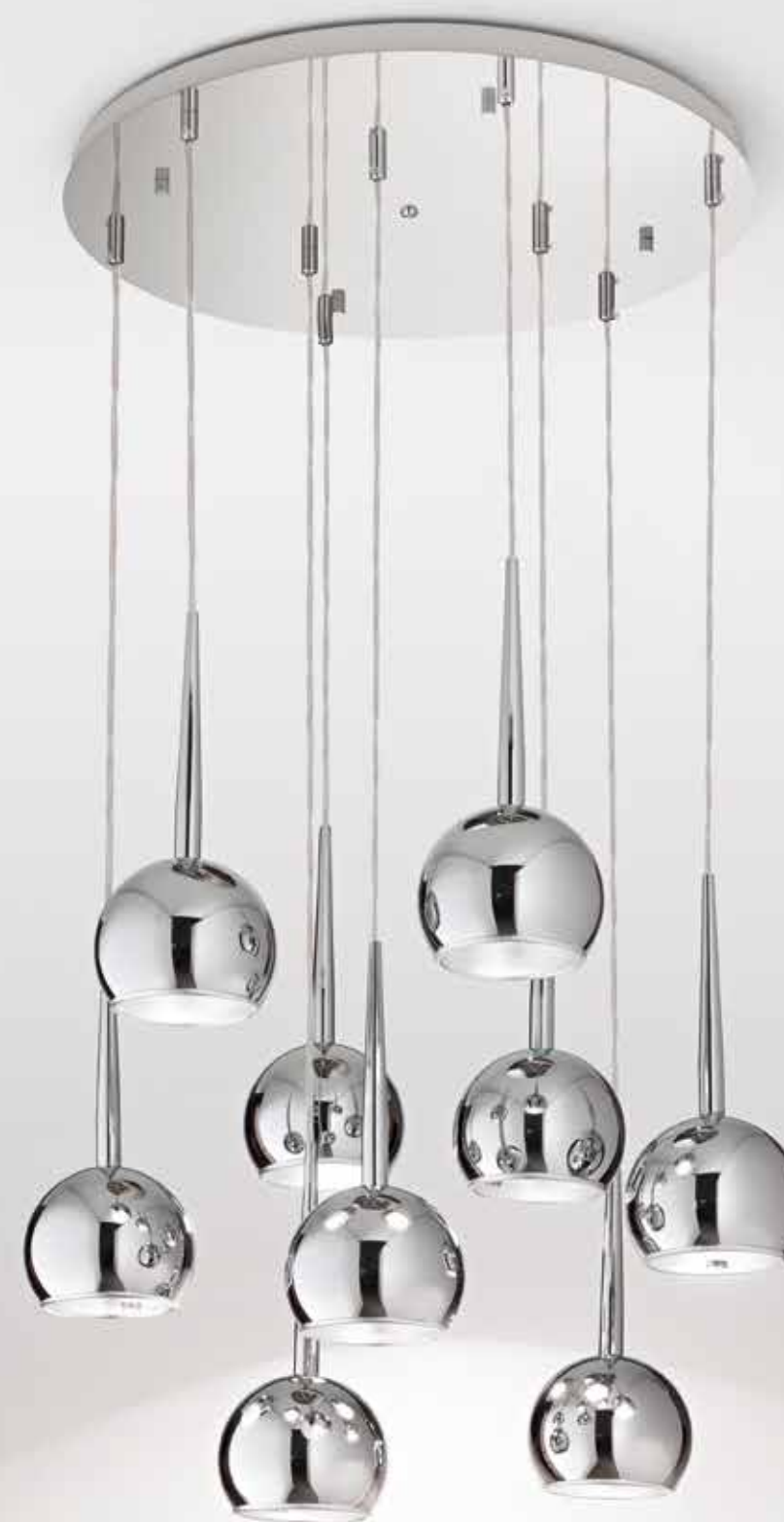
**2316**

sospensione Bol 9 luci
Bol pendant lamp 9 lights



2314
sospensione Bol 6 luci
Bol pendant lamp 6 lights



2312
sospensione Bol 3 luci
Bol pendant lamp 3 lights



2310
sospensione Bol singola
Bol pendant lamp

BOL

SFERE CROMATE / CHROMEPLATED SPHERES

_ Sospensione con struttura in metallo cromato e finitura a specchio. Riflettore interno in metallo cromato con finitura sabbata.

I pendenti possono essere regolati all'altezza desiderata. Lampadine non incluse, ma l'apparecchio è compatibile con lampadine di classe energetica dalla E alla A++.

_ Pendant lamp with chromed metal frame and mirror finish. Internal light diffuser in sanded finish chromed metal. The pendants can be adjustable to the desired height. Bulbs are not included, but the unit is compatible with bulbs of the energy class from E to A++.

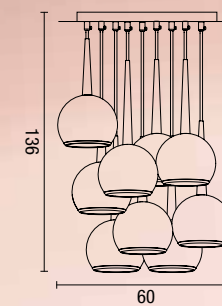

sospensione
Bol 9 luci
Bol pendant lamp
9 lights

2316

lampadine
lighting

9 x E27  57W

classe energetica
energy class

A++/E

lampadine non incluse
bulbs not included

CE
IP20

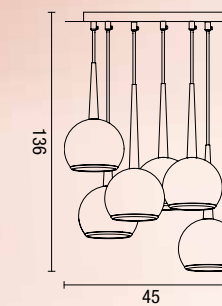

sospensione
Bol 6 luci
Bol pendant lamp
6 lights

2314

lampadine
lighting

6 x E27  57W

classe energetica
energy class

A++/E

lampadine non incluse
bulbs not included

CE
IP20

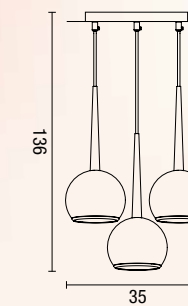

sospensione
Bol 3 luci
Bol pendant lamp
3 lights

2312

lampadine
lighting

3 x E27  57W

classe energetica
energy class

A++/E

lampadine non incluse
bulbs not included

CE
IP20

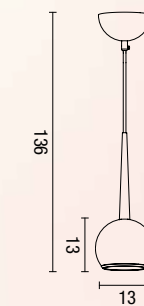

sospensione
Bol singola
Bol pendant
lamp

2310

lampadine
lighting

1 x E27  57W

classe energetica
energy class

A++/E

lampadine non incluse
bulbs not included

CE
IP20



BOLDIODI

SFERE CROMATE / CHROMEPLATED SPHERES

_ Sospensione con struttura in metallo cromato e finitura a specchio. L'apparecchio è dotato di LED da 3W con temperatura colore 3000K. La lunghezza dei cavi è regolabile.

_ Pendant lamp with chromed metal frame and mirror finish. The lamp is equipped with 3W LED and 3000K colour. The cables' length is adjustable.

2033

sospensione Bol Diodi singola
Bol Diodi pendant lamp

**2037**

sospensione Bol Diodi 9 luci
Bol Diodi pendant lamp 9 lights

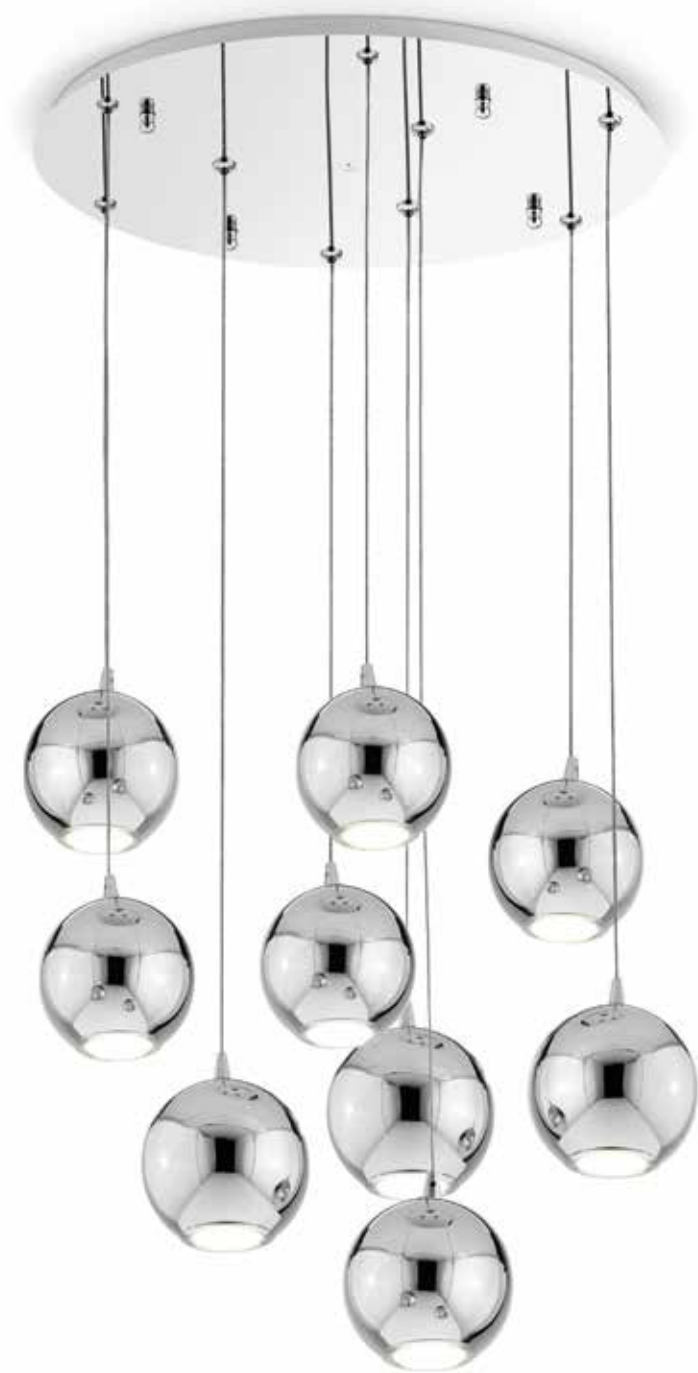

2037
sospensione Bol Diodi 9 luci
Bol Diodi pendant lamp 9 lights



2036
sospensione Bol Diodi 6 luci
Bol Diodi pendant lamp 6 lights

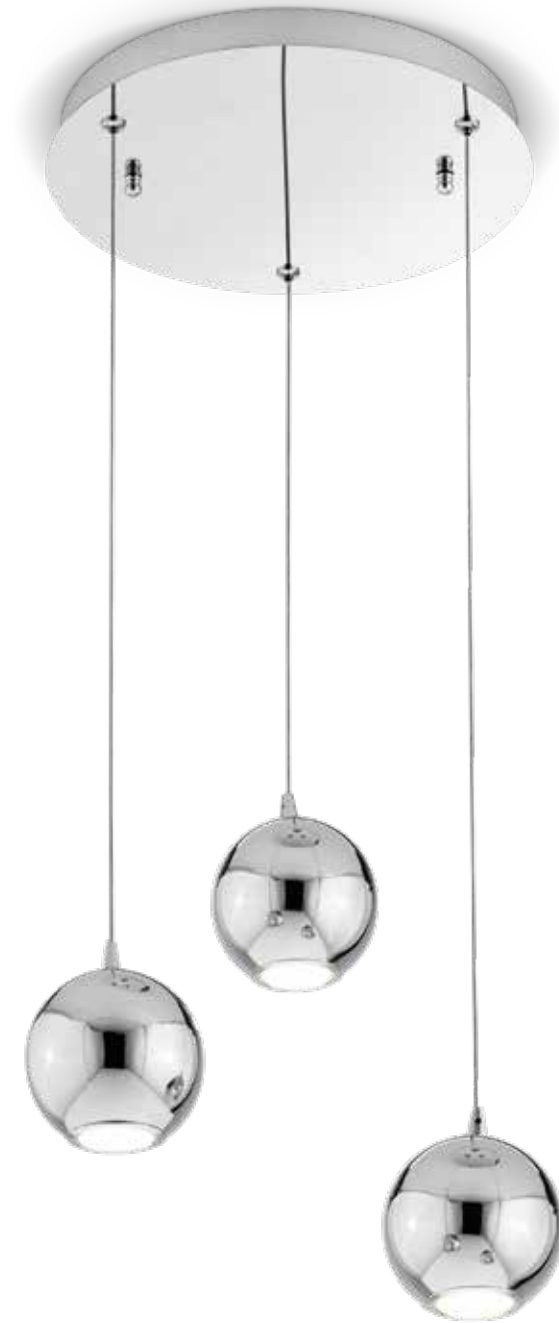

BOLDIODI

SFERE CROMATE / CHROMEPLATED SPHERES

_ Sospensione con struttura in metallo cromato e finitura a specchio. L'apparecchio è dotato di LED da 3W con temperatura colore 3000K. La lunghezza dei cavi è regolabile.
 _ Pendant lamp with chromed metal frame and mirror finish. The lamp is equipped with 3W LED and 3000K colour. The cables' length is adjustable.

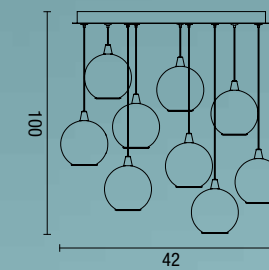

sospensione
 Bol Diodi 9 luci
 Bol Diodi pendant
 lamp 9 lights

2037

lampadine
 lighting

LED $\hat{=}$ 26W 3000K

flusso luminoso
 luminous flux

1820 lm

marca LED
 LED brand

EPISTAR

classe energetica
 energy class

A



CE
 IP20

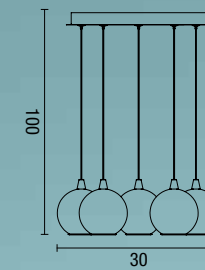

sospensione
 Bol Diodi 6 luci
 Bol Diodi pendant
 lamp 6 lights

2036

lampadine
 lighting

LED $\hat{=}$ 18W 3000K

flusso luminoso
 luminous flux

1050 lm

marca LED
 LED brand

EPISTAR

classe energetica
 energy class

A



CE
 IP20

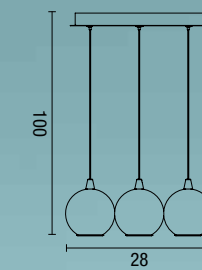

sospensione
 Bol Diodi 3 luci
 Bol Diodi pendant
 lamp 3 lights

2034

lampadine
 lighting

LED $\hat{=}$ 9W 3000K

flusso luminoso
 luminous flux

600 lm

marca LED
 LED brand

EPISTAR

classe energetica
 energy class

A



CE
 IP20

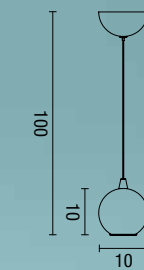

sospensione
 Bol Diodi singola
 Bol Diodi pendant
 lamp

2033

lampadine
 lighting

LED $\hat{=}$ 3W 3000K

flusso luminoso
 luminous flux

210 lm

marca LED
 LED brand

EPISTAR

classe energetica
 energy class

A



CE
 IP20

2034

sospensione Bol Diodi 3 luci
 Bol Diodi pendant lamp 3 lights

TUBIDIODI Ø

TUBI BIANCHI / WHITE PIPES

_ Sospensione cilindrica con struttura in metallo verniciato e finitura sabbata. L'apparecchio è dotato di LED da 3W con temperatura colore 3000K.

La lunghezza del cavo è regolabile.

_ Cylindrical pendant lamp with varnished metal frame and sanded finish.

The lamp is equipped with 3W LED and 3000K colour.

The cable's length is adjustable.

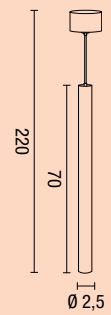

sospensione
Tubi Diodi
Tubi Diodi
pendant lamp

2025L

lampadine
lighting

LED ⚡ 1 x 3W 3000K

flusso luminoso
luminous flux

270 lm

marca LED
LED brand

CREE

classe energetica
energy class

A



IP20

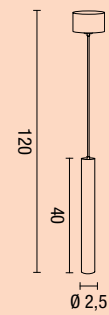

sospensione
Tubi Diodi
Tubi Diodi
pendant lamp

2025

lampadine
lighting

LED ⚡ 1 x 3W 3000K

flusso luminoso
luminous flux

270 lm

marca LED
LED brand

CREE

classe energetica
energy class

A



IP20



2025
sospensione Tubi Diodi
Tubi Diodi pendant lamp

TUBIDIODI

TUBI BIANCHI / WHITE PIPES

_ Sospensione con struttura in metallo verniciato e finitura sabbata. L'apparecchio è dotato di LED da 3W con temperatura colore 3000K. La lunghezza del cavo è regolabile.

_ Pendant lamp with varnished metal frame and sanded finish. The lamp is equipped with 3W LED and 3000K colour. The cable's length is adjustable.

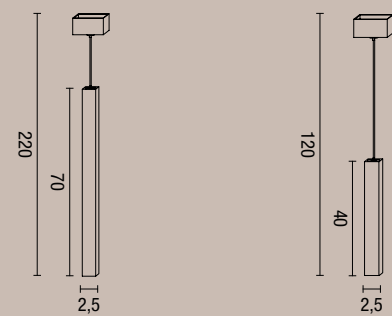

sospensione
Tubi Diodi
Tubi Diodi
pendant lamp

2026L

lampadine
lighting

LED \varnothing 1 x 3W 3000K

flusso luminoso
luminous flux

270 lm

marca LED
LED brand

CREE

classe energetica
energy class

A



CE

IP20

sospensione
Tubi Diodi
Tubi Diodi
pendant lamp

2026

lampadine
lighting

LED \varnothing 1 x 3W 3000K

flusso luminoso
luminous flux

270 lm

marca LED
LED brand

CREE

classe energetica
energy class

A



CE

IP20



2026

sospensione Tubi Diodi
Tubi Diodi pendant lamp

PARABOLEDIODI

METALLO BIANCO / WHITE METAL

_ Le sospensioni di questa serie hanno la struttura in metallo verniciato con finitura satinata. Questi apparecchi sono dotati di LED con temperatura colore 3000/3200K schermati da un diffusore in PMMA e sono adatti ad ambienti che richiedono un'illuminazione accentuata. La lunghezza dei cavi è regolabile.
 _ The pendant lamps in this serie have a metal structure with satin finish varnish. These appliances are equipped with LED in 3000/3200K colour temperature shielded by a PMMA light diffuser and are suitable for environments requiring accentuated lighting. Cables' length is adjustable.

2044

sospensione Parabola Diodi
 Parabola Diodi pendant lamp





2044
sospensione Parabola Diodi
Parabola Diodi pendant lamp

_ SOSPENSIONE CON STRUTTURA
IN METALLO VERNICIATO E FINITURA
SATINATA. L'APPARECCHIO È DOTATO
DI LED CON TEMPERATURA COLORE
3000K SCHERMATI DA UN DIFFUSORE
IN PMMA. LA LUNGHEZZA DEL CAVI È
REGOLABILE _ PENDANT LAMP WITH
VARNISHED METAL FRAME AND SATIN
FINISH. THE LAMP IS EQUIPPED WITH
LED IN 3000K COLOUR TEMPERATURE
SHIELDED BY A PMMA LIGHT DIFFUSER.
THE CABLE'S LENGTH IS ADJUSTABLE.



2042
sospensione Parabola Diodi
Parabola Diodi pendant lamp



2032

sospensione Parabola Diodi
Parabola Diodi pendant lamp

_ SOSPENSIONE CON STRUTTURA IN ALLUMINIO VERNICIATO E FINITURA SATINATA. L'APPARECCHIO È DOTATO DI DIFFUSORE IN PMMA, CON LED DA 17W VERSO IL SOFFITTO E 34W VERSO IL PAVIMENTO. TEMPERATURA COLORE 3200K. LA LUNGHEZZA DEI CAVI È REGOLABILE _ PENDANT LAMP WITH VARNISHED ALUMINUM FRAME AND SATIN FINISH. THE LAMP IS EQUIPPED WITH PMMA LIGHT DIFFUSER AND LED WITH 17W TOWARDS THE CEILING AND 34W TOWARDS THE FLOOR; 3200K COLOUR. THE CABLE'S LENGTH IS ADJUSTABLE.

_ SOSPENSIONE CON STRUTTURA IN ALLUMINIO VERNICIATO E FINITURA SATINATA. L'APPARECCHIO È DOTATO DI LED CON TEMPERATURA COLORE 3200K SCHERMATI DA UN DIFFUSORE IN PMMA. I LED SONO MONTATI VERSO L'INTERNO E LA STRUTTURA È APERTA SIA VERSO IL SOFFITTO CHE VERSO IL PAVIMENTO. LA LUNGHEZZA DEI CAVI È REGOLABILE _ PENDANT LAMP WITH VARNISHED ALUMINUM FRAME AND SATIN FINISH. THE LAMP IS EQUIPPED WITH PMMA LIGHT DIFFUSER. LED 3200K COLOUR MOUNTED TOWARDS THE INSIDE AND THE STRUCTURE IS OPEN ON BOTH SIDES. THE CABLE'S LENGTH IS ADJUSTABLE.



2056

sospensione Parabola Diodi
Parabola Diodi pendant lamp

2055

sospensione Parabola Diodi
Parabola Diodi pendant lamp

_ SOSPENSIONE CON STRUTTURA IN ALLUMINIO VERNICIATO E FINITURA SATINATA. L'APPARECCHIO È DOTATO DI LED CON TEMPERATURA COLORE 3200K SCHERMATI DA UN DIFFUSORE IN PMMA. I LED SONO MONTATI VERSO L'INTERNO E LA STRUTTURA È APERTA SIA VERSO IL SOFFITTO CHE VERSO IL PAVIMENTO. LA LUNGHEZZA DEI CAVI È REGOLABILE
 _ PENDANT LAMP WITH VARNISHED ALUMINUM FRAME AND SATIN FINISH. THE LAMP IS EQUIPPED WITH PMMA LIGHT DIFFUSER. LED 3200K COLOUR MOUNTED TOWARDS THE INSIDE AND THE STRUCTURE IS OPEN ON BOTH SIDES. THE CABLE'S LENGTH IS ADJUSTABLE.



2031

sospensione Parabola Diodi
 Parabola Diodi pendant lamp

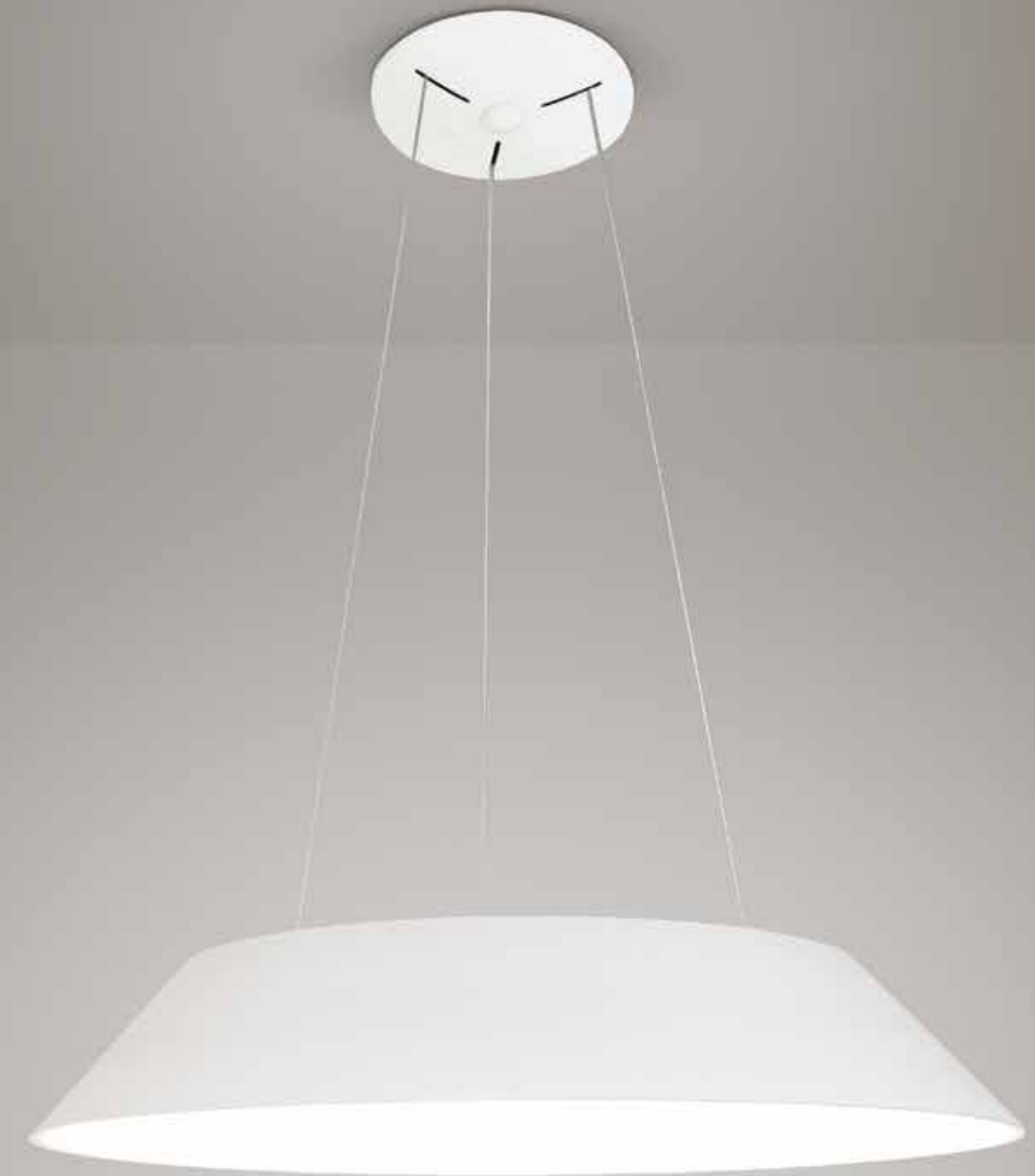

2054

sospensione Parabola Diodi
 Parabola Diodi pendant lamp

_ SOSPENSIONE CON STRUTTURA IN ALLUMINIO VERNICIATO E FINITURA SATINATA. L'APPARECCHIO È DOTATO DI LED CON TEMPERATURA COLORE 3200K SCHERMATI DA UN DIFFUSORE IN PMMA. LA LUNGHEZZA DEI CAVI È REGOLABILE
 _ PENDANT LAMP WITH VARNISHED ALUMINUM FRAME AND SATIN FINISH. THE LAMP IS EQUIPPED WITH LED AND 3200K COLOUR TEMPERATURE SHIELDED BY A PMMA LIGHT DIFFUSER. THE CABLES' LENGTH IS ADJUSTABLE.

PARABOLE DIODI

METALLO BIANCO / WHITE METAL

_ Sospensione con struttura in metallo verniciato e finitura satinata. L'apparecchio è dotato di LED con temperatura colore 3000K schermati da un diffusore in PMMA. La lunghezza dei cavi è regolabile.

_ Pendant lamp with varnished metal frame and satin finish. The lamp is equipped with LED in 3000K colour temperature shielded by a PMMA light diffuser. The cable's length is adjustable.

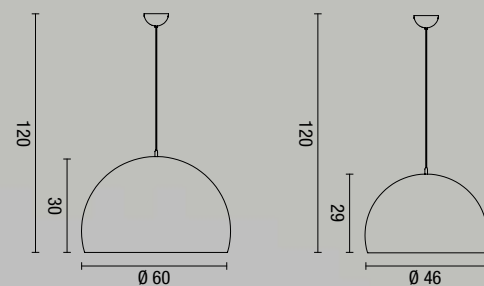

sospensione
Parabola Diodi
Parabola Diodi
pendant lamp

2044

lampadine
lighting

LED SMD 60W 3000K

flusso luminoso
luminous flux

4200 lm

marca LED
LED brand

EPISTAR

classe energetica
energy class

A



CE

IP20

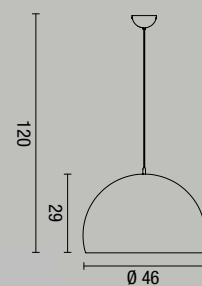

sospensione
Parabola Diodi
Parabola Diodi
pendant lamp

2042

lampadine
lighting

LED SMD 42W 3000K

flusso luminoso
luminous flux

2940 lm

marca LED
LED brand

EPISTAR

classe energetica
energy class

A



CE

IP20

_ Sospensione con struttura in alluminio verniciato e finitura satinata. L'apparecchio è dotato di diffusore in PMMA, con LED da 17W verso il soffitto e 34W verso il pavimento. Temperatura colore 3200K. La lunghezza dei cavi è regolabile.

_ Pendant lamp with varnished aluminum frame and satin finish. The lamp is equipped with PMMA light diffuser and LED with 17W towards the ceiling and 34W towards the floor; 3200K colour. The cable's length is adjustable.

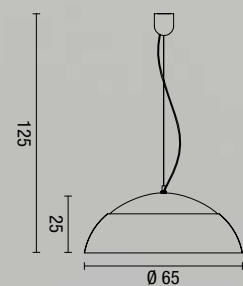

sospensione
Parabola Diodi
Parabola Diodi
pendant lamp

2032

lampadine
lighting

LED SMD 50W 3200K

flusso luminoso
luminous flux

3500 lm

marca LED
LED brand

EPISTAR

classe energetica
energy class

A



CE

IP20

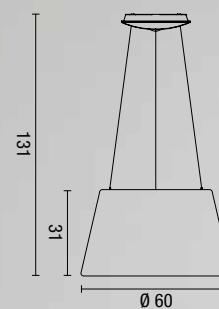

sospensione
Parabola Diodi
Parabola Diodi
pendant lamp

2055

lampadine
lighting

LED SMD 50W 3200K

flusso luminoso
luminous flux

3500 lm

marca LED
LED brand

EPISTAR

classe energetica
energy class

A



CE

IP20

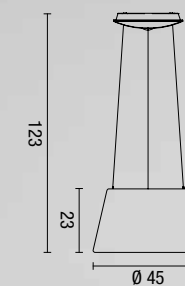

sospensione
Parabola Diodi
Parabola Diodi
pendant lamp

2056

lampadine
lighting

LED SMD 30W 3200K

flusso luminoso
luminous flux

2100 lm

marca LED
LED brand

EPISTAR

classe energetica
energy class

A



CE

IP20

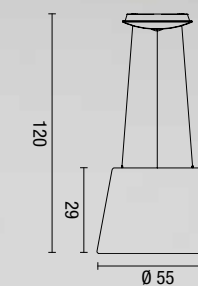

sospensione
Parabola Diodi
Parabola Diodi
pendant lamp

2031

lampadine
lighting

LED SMD 63W 3200K

flusso luminoso
luminous flux

4400 lm

marca LED
LED brand

EPISTAR

classe energetica
energy class

A



CE

IP20

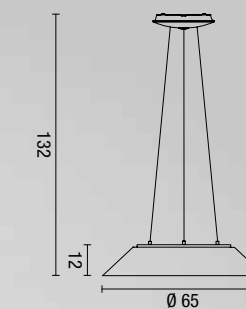

sospensione
Parabola Diodi
Parabola Diodi
pendant lamp

2054

lampadine
lighting

LED SMD 30W 3200K

flusso luminoso
luminous flux

2100 lm

marca LED
LED brand

EPISTAR

classe energetica
energy class

A



CE

IP20

_ Sospensione con struttura in alluminio verniciato e finitura satinata. L'apparecchio è dotato di LED con temperatura colore 3200K schermati da un diffusore in PMMA. I LED sono montati verso l'interno e la struttura è aperta sia verso il soffitto che verso il pavimento. La lunghezza dei cavi è regolabile.

_ Pendant lamp with varnished aluminum frame and satin finish. The lamp is equipped with PMMA light diffuser. LED 3200K colour mounted towards the inside and the structure is open on both sides. The cable's length is adjustable.

_ Sospensione con struttura in alluminio verniciato e finitura satinata. L'apparecchio è dotato di LED con temperatura colore 3200K schermati da un diffusore in PMMA. La lunghezza dei cavi è regolabile.

_ Pendant lamp with varnished aluminum frame and satin finish. The lamp is equipped with LED and 3200K colour temperature shielded by a PMMA light diffuser. The cables' length is adjustable.



HEMIDARK

CRISTALLI FUMÉ CON FINITURA DICROICA /
DARK CRYSTALS WITH DICHOIC FINISH

_ La serie Hemidark è caratterizzata dall'impiego di cristallo fumé con effetto dicroico. Questi modelli hanno la struttura in metallo, con piastra in acciaio inox lucidata a specchio. Montano delle catenelle di ottagoni sfaccettati in cristallo neutro, con il finale a mandorla fumé. Le lampadine incluse sono alogene di classe energetica D che possono essere sostituite con lampadine a LED di classe A+/A.

_ The Hemidark collection is distinguished by the use of dark colour crystal with dichroic effect. All the items in this serie are made with a metal structure that carries a stainless steel metal sheet with mirror finish. The chains are made of octagonals beveled beads in clear crystal with final dark almond shaped crystal. The supplied light bulbs are class D halogen that can be replaced with class A+/A LED models.

2279S

plafoniera Hemidark
Hemidark ceiling lamp

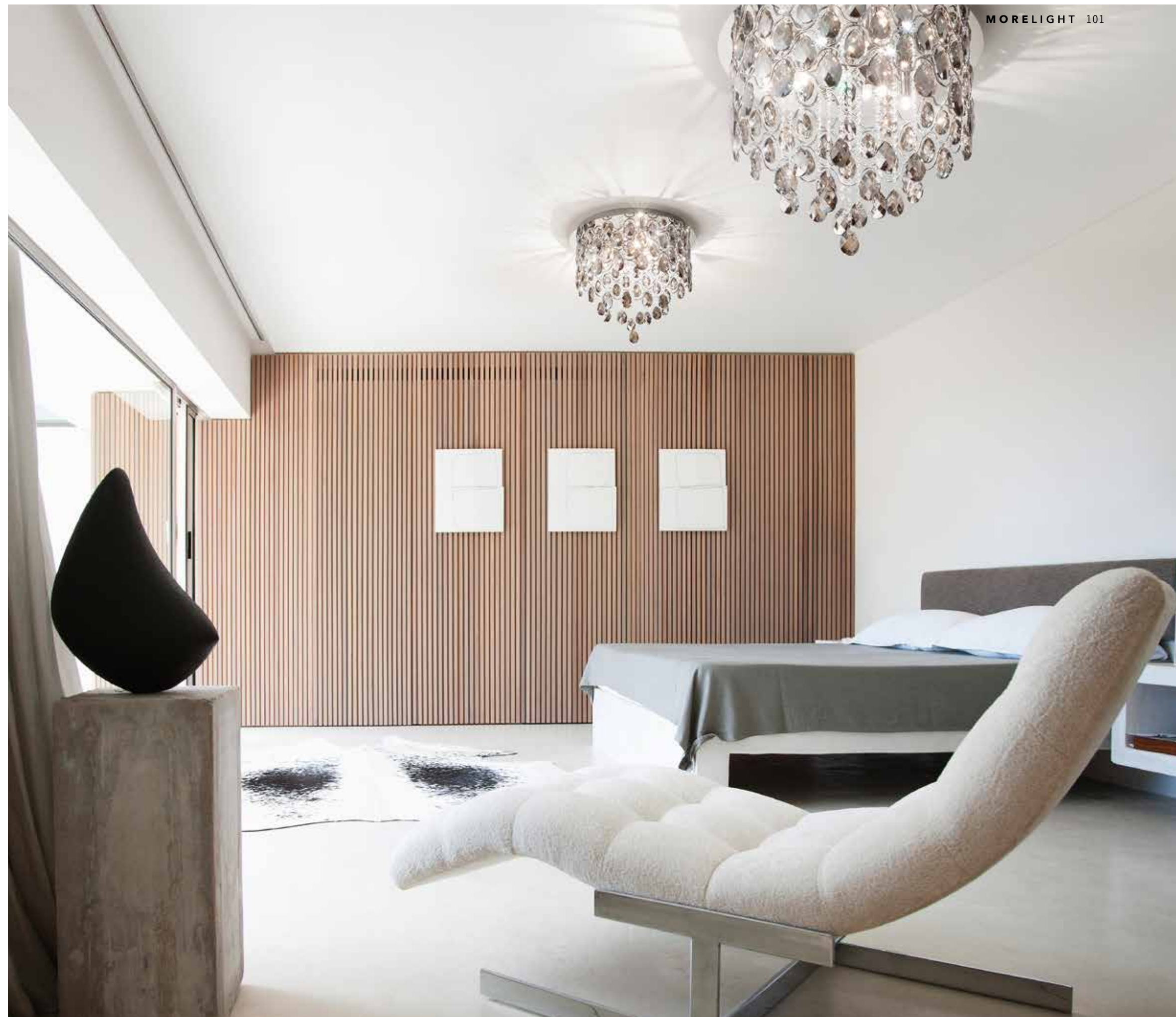



2279
sospensione Hemidark
Hemidark pendant lamp



2278
applique Hemidark
Hemidark wall lamp



2279L
lampada da tavolo Hemidark
Hemidark table lamp

HEMIDARK

CRISTALLI FUMÉ CON FINITURA DICROICA /
DARK CRYSTALS WITH DICHROIC FINISH

La serie Hemidark è caratterizzata dall'impiego di cristallo fumé con effetto dicroico. Anche questi modelli hanno la struttura in metallo, con piastra in acciaio inox lucidata a specchio. Montano delle catenelle di ottagoni sfaccettati in cristallo neutro, con il finale a mandorla fumé. Le lampadine incluse sono alogene di classe energetica D che possono essere sostituite con lampadine a LED di classe A+/A.

The Hemidark collection is distinguished by the use of dark colour crystal with dichroic effect. All the items in this serie are made with a metal structure that carries a stainless steel metal sheet with mirror finish. The chains are made of octagonals beveled beads in clear crystal with final dark almond shaped crystal. The supplied light bulbs are class D halogen that can be replaced with class A+/A LED models.



luce con solo
lampadine LED
light with only
LED bulbs

luce con solo
lampadine alogene
light with only
halogen bulbs

luce con lampadine
alogene + LED
light with
halogen + LED bulbs

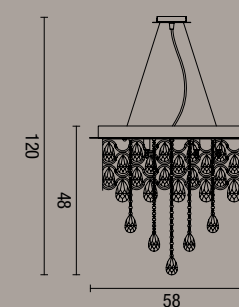

sospensione Hemidark
Hemidark pendant lamp

2279

lampadine
lighting

6 x G9 40W

classe energetica
energy class

D (A+/A)

lampadine
lighting

LED 9 x 1W 6000K

flusso luminoso
luminous flux

630 lm

marca LED
LED brand

EPISTAR

classe energetica
energy class

A



CE
IP20

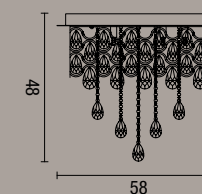

plafoniera Hemidark
Hemidark ceiling lamp

2279S

lampadine
lighting

6 x G9 40W

classe energetica
energy class

D (A+/A)

lampadine
lighting

LED 9 x 1W 6000K

flusso luminoso
luminous flux

630 lm

marca LED
LED brand

EPISTAR

classe energetica
energy class

A



CE
IP20

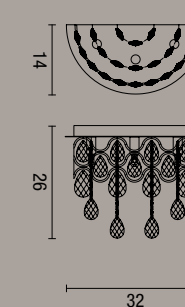

applique Hemidark
Hemidark wall lamp

2278

lampadine
lighting

3 x G9 40W

classe energetica
energy class

D (A+/A)

CE
IP20

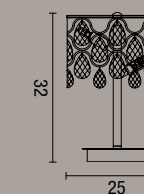

lampada da tavolo
Hemidark
Hemidark table lamp

2279L

lampadine
lighting

3 x G9 40W

classe energetica
energy class

D (A+/A)

CE
IP20

FRANGIA

ACCIAIO INOX / STAINLESS STEEL

_ La serie Frangia monta cristalli a mattonella con un cristallo finale a losanga. La struttura è in metallo cromato con piastra in acciaio inox lucidata a specchio. Le lampadine incluse sono alogene di classe energetica D che possono essere sostituite con lampadine a LED di classe A+/A.

_ Frangia style is made with square crystals with a final lozenge shaped crystal. The metal structure carries a stainless steel metal sheet with mirror finish. The supplied light bulbs are class D halogen that can be replaced with class A+/A LED models.

2195

sospensione Frangia grande
Frangia large pendant lamp





2195
sospensione Frangia grande
Frangia large pendant lamp



2194
sospensione Frangia piccola
Frangia small pendant lamp



2184
plafoniera rettangolare Frangia grande
Frangia large rectangular ceiling lamp



2183
plafoniera rettangolare Frangia grande
Frangia large rectangular ceiling lamp





2196
plafoniera quadrata Frangia grande
Frangia large square ceiling lamp



2185
plafoniera quadrata Frangia piccola
Frangia small square ceiling lamp



2187
plafoniera tonda Frangia grande
Frangia large round ceiling lamp



2188
plafoniera tonda Frangia piccola
Frangia small round ceiling lamp



2231
applique Frangia rettangolare
Frangia rectangular wall lamp



2230
applique Frangia tonda
Frangia round wall lamp



2200
lampada da tavolo Frangia
Frangia table lamp

FRANGIA

ACCIAIO INOX / STAINLESS STEEL

_ La serie Frangia monta cristalli a mattonella con un cristallo finale a losanga. La struttura è in metallo cromato con piastra in acciaio inox lucidata a specchio. Le lampadine incluse sono alogene di classe energetica D che possono essere sostituite con lampadine a LED di classe A+/A.

_ Frangia style is made with square crystals with a final lozenge shaped crystal. The metal structure carries a stainless steel metal sheet with mirror finish. The supplied light bulbs are class D halogen that can be replaced with class A+/A LED models.

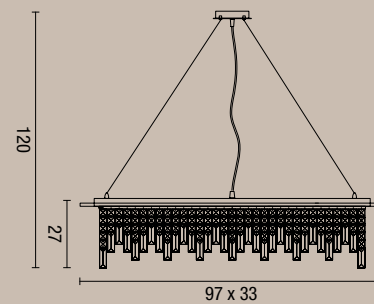

sospensione
Frangia grande
Frangia large
pendant lamp
2195

lampadine
lighting
10 x G9  40W
classe energetica
energy class
D (A+/A)

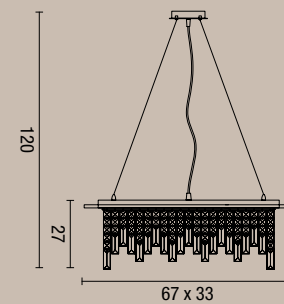

IP20



sospensione
Frangia piccola
Frangia small
pendant lamp
2194

lampadine
lighting
8 x G9  40W
classe energetica
energy class
D (A+/A)

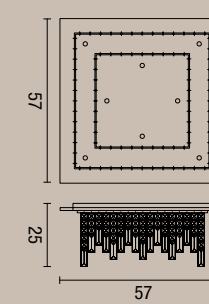

IP20



plafoniera quadrata
Frangia grande
Frangia large
square ceiling lamp
2196

lampadine
lighting
12 x G9  40W
classe energetica
energy class
D (A+/A)

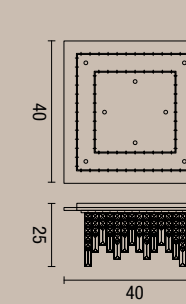

IP20



plafoniera quadrata
Frangia piccola
Frangia small
square ceiling lamp
2185

lampadine
lighting
8 x G9  40W
classe energetica
energy class
D (A+/A)

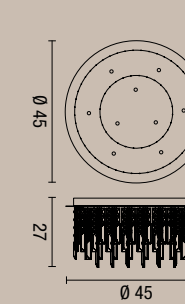

IP20



plafoniera tonda
Frangia grande
Frangia large
round ceiling lamp
2187

lampadine
lighting
9 x G9  40W
classe energetica
energy class
D (A+/A)

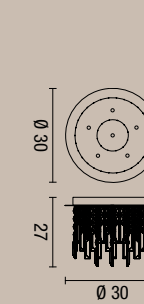

IP20



plafoniera tonda
Frangia piccola
Frangia small
round ceiling lamp
2188

lampadine
lighting
6 x G9  40W
classe energetica
energy class
D (A+/A)

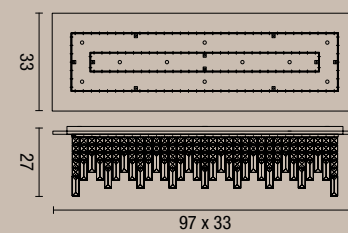

IP20



plafoniera rettangolare
Frangia grande
Frangia large
rectangular ceiling lamp
2184

lampadine
lighting
10 x G9  40W
classe energetica
energy class
D (A+/A)

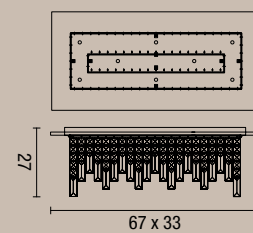

IP20



plafoniera rettangolare
Frangia grande
Frangia large
rectangular ceiling lamp
2183

lampadine
lighting
8 x G9  40W
classe energetica
energy class
D (A+/A)

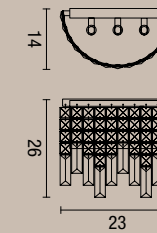

IP20



applique
Frangia tonda
Frangia round
wall lamp
2230

lampadine
lighting
3 x G9  40W
classe energetica
energy class
D (A+/A)

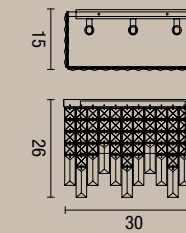

IP20



applique
Frangia rettangolare
Frangia rectangular
wall lamp
2231

lampadine
lighting
3 x G9  40W
classe energetica
energy class
D (A+/A)

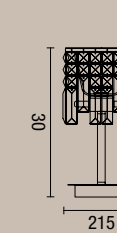
IP20



lampada da tavolo
Frangia
Frangia
table lamp
2200

lampadine
lighting
2 x G9  40W
classe energetica
energy class
D (A+/A)

IP20

ROTONDO

ACCIAIO INOX / STAINLESS STEEL

_ Questa serie di articoli prende il nome dal tipo di cristallo utilizzato che è a taglio rotondo. Tutti modelli a plafone, si distinguono per la loro luminosità e si adattano a qualsiasi ambiente. La struttura è in metallo cromato con la piastra riflettente in acciaio inox e finitura a specchio. Le lampadine incluse sono alogene di classe energetica D che possono essere sostituite con lampadine a LED di classe A+/A.

_ This collection takes its name from the cut of its crystal elements, as "rotondo" means round. All models have the ceiling mount; finding location in every place they distinguish by their high luminosity. The structure is made of chromeplated metal, with a mirror-finished stainless steel reflective surface. The supplied light bulbs are class D halogen that can be replaced with class A+/A LED models.

3144

plafoniera tonda Rotondo grande
Rotondo round ceiling lamp large





3147
plafoniera quadrata Rotondo grande
Rotondo square ceiling lamp large



3144
plafoniera tonda Rotondo grande
Rotondo round ceiling lamp large



3145
plafoniera quadrata Rotondo piccola
Rotondo square ceiling lamp small



3151
plafoniera tonda Rotondo piccola
Rotondo round ceiling lamp small



3148
plafoniera Rotondo romboide
Rotondo rhomboid ceiling lamp



3150
applique Rotondo
Rotondo wall lamp

ROTONDO

ACCIAIO INOX / STAINLESS STEEL

_ Questa serie di articoli prende il nome dal tipo di cristallo utilizzato che è a taglio rotondo. Tutti modelli a plafone, si distinguono per la loro luminosità e si adattano a qualsiasi ambiente. La struttura è in metallo cromato con la piastra riflettente in acciaio inox e finitura a specchio. Le lampadine incluse sono alogene di classe energetica D che possono essere sostituite con lampadine a LED di classe A+/A.

_ This collection takes its name from the cut of its crystal elements, as "rotondo" means round. All models have the ceiling mount; finding location in every place they distinguish by their high luminosity. The structure is made of chromeplated metal, with a mirror-finished stainless steel reflective surface. The supplied light bulbs are class D halogen that can be replaced with class A+/A LED models.

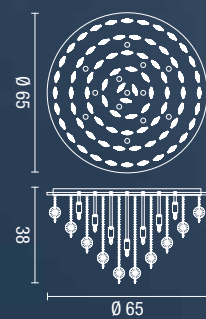

plafoniera tonda
Rotondo grande
Rotondo round
ceiling lamp large

3144

lampadine
lighting

12 x G9 40W

classe energetica
energy class

D (A+/A)

CE
IP20

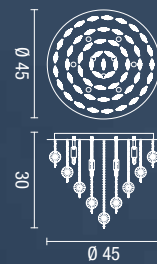

plafoniera tonda
Rotondo piccola
Rotondo round
ceiling lamp small

3151

lampadine
lighting

9 x G9 40W

classe energetica
energy class

D (A+/A)

CE
IP20

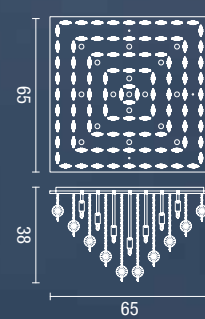

plafoniera quadrata
Rotondo grande
Rotondo square
ceiling lamp large

3147

lampadine
lighting

14 x G9 40W

classe energetica
energy class

D (A+/A)

CE
IP20

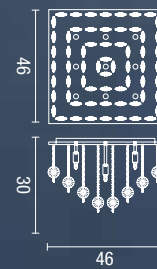

plafoniera quadrata
Rotondo piccola
Rotondo square
ceiling lamp small

3145

lampadine
lighting

9 x G9 40W

classe energetica
energy class

D (A+/A)

CE
IP20

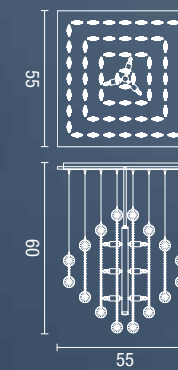

plafoniera Rotondo
romboide
Rotondo rhomboid
ceiling lamp

3148

lampadine
lighting

9 x G9 40W

classe energetica
energy class

D (A+/A)

CE
IP20

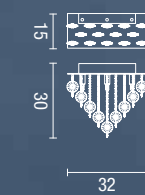

applique Rotondo
Rotondo wall lamp

3150

lampadine
lighting

3 x G9 40W

classe energetica
energy class

D (A+/A)

CE
IP20



CRYSTALLIVS

CROMO/NEUTRO, CROMO/FUMÈ, OTTONE/AMBRA
CHROME/CLEAR, CHROME/SMOKED, BRASS/AMBER

— Questa serie di articoli è composta da metallo placcato in abbinamento ad accessori in vetro. Disponibile in 3 varianti, due su base cromata con vetro molato neutro oppure fumè in aggiunta alla versione ottonata con vetro di colore ambra. Quattro diverse misure di plafoniera, pensate per adattarsi facilmente ad ambienti di varie dimensioni, offrono anche quattro diversi tipi di luminosità. Le lampadine non sono fornite, ma su questa serie si possono montare diversi tipi di lampadina che spaziano dalle alogene a quelle a LED con zoccolo E14.

— This collection is made by plated metal in combination with glass accessories. Available in three variants, two of them on chromeplated base with beveled glass in clear and and smoked coloured in addition to the brass-plated base and amber colour glass. Four different sizes of ceiling lamps thought to be suitable for ambients of various dimensions also offer different power. We do not supply the light bulbs, but on this serie several models of E14 light bulbs can be mounted, ranging from halogen to LED.



2089CF

plafoniera Crystallivs 10 luci cromo/fumè
chrome/smoked Crystallivs ceiling lamp 10 lights



2089CF
plafoniera Crystallivs 10 luci cromo/fumè
chrome/smoked Crystallivs ceiling lamp 10 lights



2087C
plafoniera Crystallivs 6 luci cromo/neutro
chrome/clear Crystallivs ceiling lamp 6 lights



2088
plafoniera Crystallivs 8 luci ottone/ambra
brass/amber Crystallivs ceiling lamp 8 lights



2086
plafoniera Crystallivs 3 luci ottone/ambra
brass/amber Crystallivs ceiling lamp 3 lights



2090CF
applique Crystallivs cromo/fumè
chrome/smoked Crystallivs wall lamp

2090C
applique Crystallivs cromo/neutro
chrome/clear Crystallivs wall lamp

2090
applique Crystallivs ottone/ambra
brass/amber Crystallivs wall lamp

CRYSTALLIVS

CROMO/NEUTRO, CROMO/FUMÈ, OTTONE/AMBRA
CHROME/CLEAR, CHROME/SMOKED, BRASS/AMBER

_ Questa serie di articoli è composta da metallo placcato in abbinamento ad accessori in vetro. Disponibile in 3 varianti, due su base cromata con vetro molato neutro oppure fumè in aggiunta alla versione ottonata con vetro di colore ambra. Quattro diverse misure di plafoniera, pensate per adattarsi facilmente ad ambienti di varie dimensioni, offrono anche quattro diversi tipi di luminosità. Le lampadine non sono fornite, ma su questa serie si possono montare diversi tipi di lampadina che spaziano dalle alogene a quelle a LED con zoccolo E14.

_ This collection is made by plated metal in combination with glass accessories. Available in three variants, two of them on chromeplated base with beveled glass in clear and and smoked coloured in addition to the brass-plated base and amber colour glass. Four different sizes of ceiling lamps thought to be suitable for ambients of various dimensions also offer different power. We do not supply the light bulbs, but on this serie several models of E14 light bulbs can be mounted, ranging from halogen to LED.



cromo/neutro
chrome/clear

cromo/fumè
chrome/smoked

ottone/ambra
brass/amber

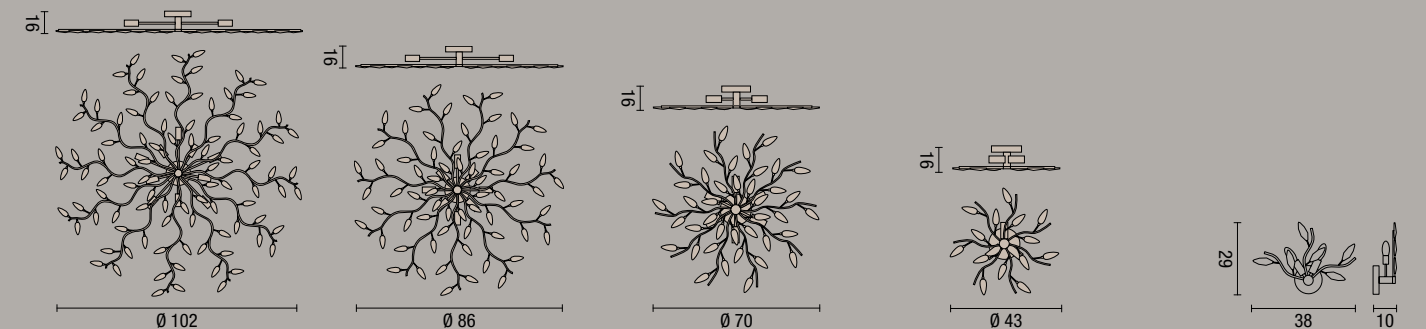

plafoniera
Crystallivs 10 luci
Crystallivs ceiling lamp
10 lights

cromo/neutro 2089C
chrome/clear
cromo/fumè 2089CF
chrome/smoked
ottone/ambra 2089
brass/amber

lampadine
lighting
10 x E14 40W
classe energetica
energy class
A++/E

lampadine non include
bulbs not included

CE
IP20

plafoniera
Crystallivs 8 luci
Crystallivs ceiling lamp
8 lights

cromo/neutro 2088C
chrome/clear
cromo/fumè 2088CF
chrome/smoked
ottone/ambra 2088
brass/amber

lampadine
lighting
8 x E14 40W
classe energetica
energy class
A++/E

lampadine non include
bulbs not included

CE
IP20

plafoniera
Crystallivs 6 luci
Crystallivs ceiling lamp
6 lights

cromo/neutro 2087C
chrome/clear
cromo/fumè 2087CF
chrome/smoked
ottone/ambra 2087
brass/amber

lampadine
lighting
6 x E14 40W
classe energetica
energy class
A++/E

lampadine non include
bulbs not included

CE
IP20

plafoniera
Crystallivs 3 luci
Crystallivs ceiling lamp
3 lights

cromo/neutro 2086C
chrome/clear
cromo/fumè 2086CF
chrome/smoked
ottone/ambra 2086
brass/amber

lampadine
lighting
3 x E14 40W
classe energetica
energy class
A++/E

lampadine non include
bulbs not included

CE
IP20

applique Crystallivs
Crystallivs wall lamp

cromo/neutro 2090C
chrome/clear
cromo/fumè 2090CF
chrome/smoked
ottone/ambra 2090
brass/amber

lampadine
lighting
2 x E14 40W
classe energetica
energy class
A++/E

lampadine non include
bulbs not included

CE
IP20

NORA3

ACCIAIO INOX / STAINLESS STEEL

_ La struttura è in acciaio inox con finitura a specchio con incastonate mattonelle in cristallo. I cavetti di tutti i modelli in questa serie sono regolabili singolarmente, in modo da posizionare gli elementi in altezza ed inclinazione desiderati. Uno dei cavetti è coassiale ed alimenta i moduli LED.

_ The structure is made of stainless steel with mirror finish tiles with embedded crystal. The cables of all the models in this serie are adjustable independently enabling you to adjust height and angle as you prefer.

2201/3

sospensione Nora3 triplo anello
Nora3 triple rings pendant lamp

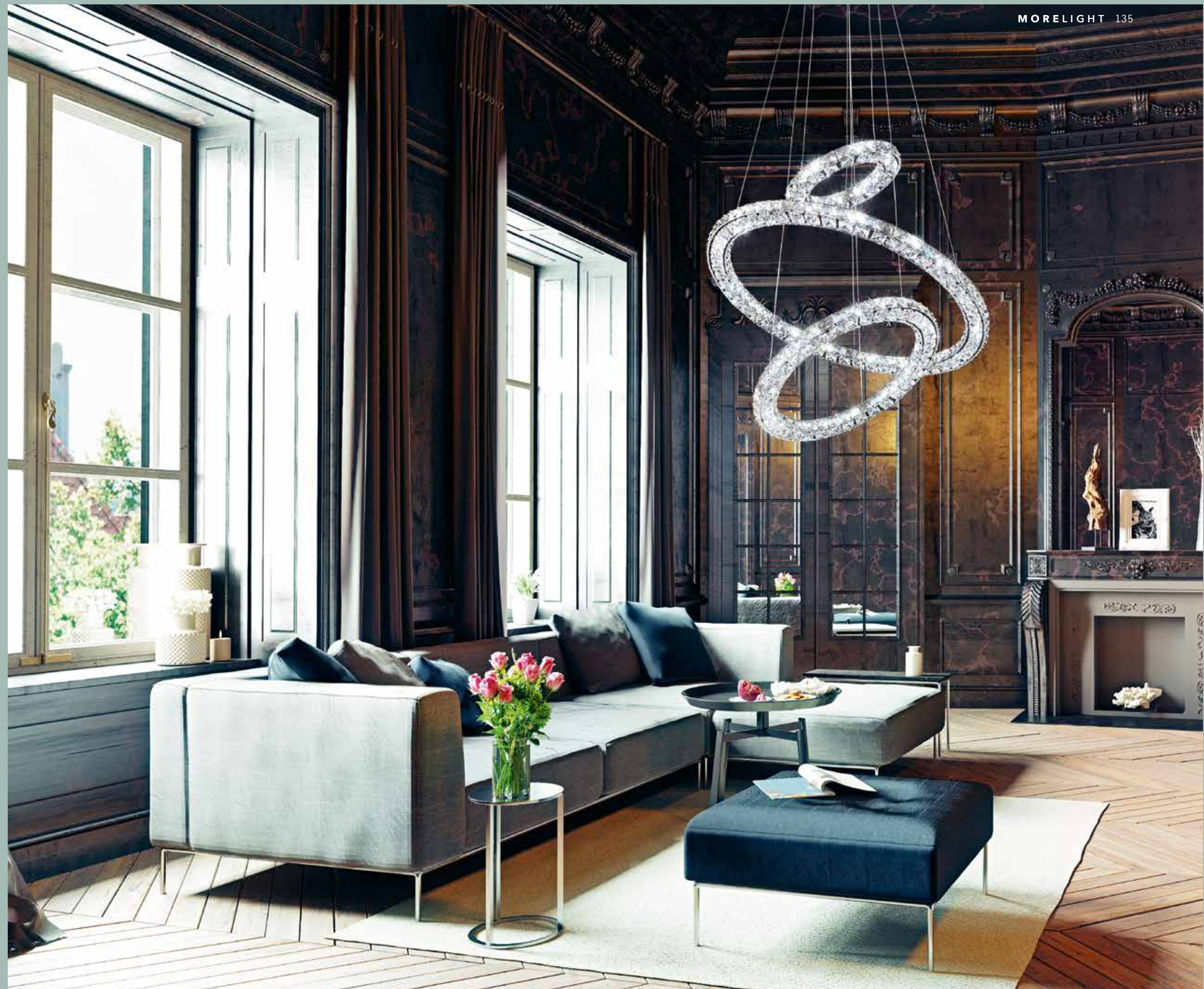



2202/3
sospensione Nora3 doppio anello
Nora3 double rings pendant lamp

2201/3
sospensione Nora3 triplo anello
Nora3 triple rings pendant lamp

_ CONFIGURAZIONE CON ANELLI MULTIPLI. VERSIONE MOLTO LUMINOSA CON GLI ELEMENTI POSIZIONABILI
A PIACIMENTO _ CONFIGURATION WITH MULTIPLE RINGS. THIS VERSION IS VERY BRIGHT AND THE
DIFFERENT RIGS CAN BE POSITIONED AT WILL.



2177/3
sospensione Nora3 grande
Nora3 large pendant lamp



2176/3
sospensione Nora3 media
Nora3 medium pendant lamp



2180/3
lampada da tavolo Nora3
Nora3 table lamp



NORA3

ACCIAIO INOX / STAINLESS STEEL

_ La struttura è in acciaio inox con finitura a specchio con incastonate mattonelle in cristallo. I cavetti di tutti i modelli in questa serie sono regolabili singolarmente, in modo da posizionare gli elementi in altezza ed inclinazione desiderati. Uno dei cavetti è coassiale ed alimenta i moduli LED.

_ The structure is made of stainless steel with mirror finish tiles with embedded crystal. The cables of all the models in this serie are adjustable independently enabling you to adjust height and angle as you prefer.

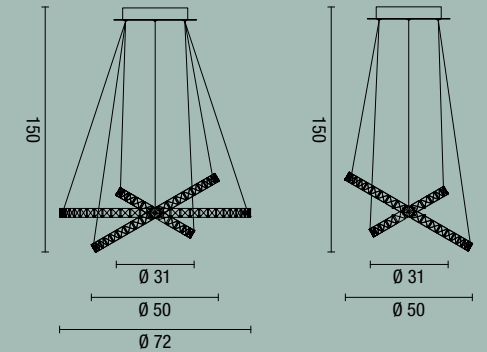

sospensione Nora3
triplo anello
Nora3 triple rings
pendant lamp

2201/3

lampadine
lighting

LED $\hat{=}$ SMD 69W 4000K

flusso luminoso
luminous flux

4140 lm

marca LED
LED brand

EPISTAR

classe energetica
energy class

A



sospensione Nora3
doppio anello
Nora3 double rings
pendant lamp

2202/3

lampadine
lighting

LED $\hat{=}$ SMD 34W 4000K

flusso luminoso
luminous flux

2040 lm

marca LED
LED brand

EPISTAR

classe energetica
energy class

A

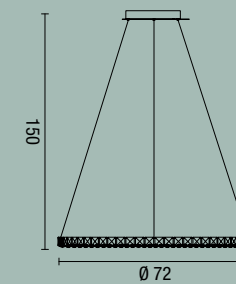

sospensione
Nora3 grande
Nora3 large
pendant lamp

2177/3

lampadine
lighting

LED $\hat{=}$ SMD 34W 4000K

flusso luminoso
luminous flux

2040 lm

marca LED
LED brand

EPISTAR

classe energetica
energy class

A

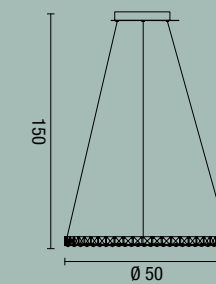

sospensione
Nora3 media
Nora3 medium
pendant lamp

2176/3

lampadine
lighting

LED $\hat{=}$ SMD 23W 4000K

flusso luminoso
luminous flux

1380 lm

marca LED
LED brand

EPISTAR

classe energetica
energy class

A

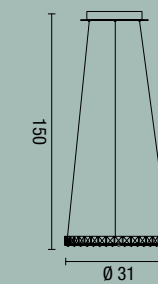

sospensione
Nora3 piccola
Nora3 small
pendant lamp

2186/3

lampadine
lighting

LED $\hat{=}$ MD 12W 4000K

flusso luminoso
luminous flux

720 lm

marca LED
LED brand

EPISTAR

classe energetica
energy class

A

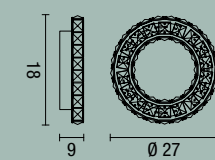

applique Nora3
Nora3 wall lamp

2181/3

lampadine
lighting

LED $\hat{=}$ SMD 12W 4000K

flusso luminoso
luminous flux

720 lm

marca LED
LED brand

EPISTAR

classe energetica
energy class

A

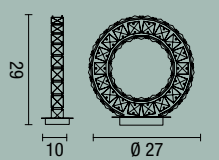

lampada da tavolo Nora3
Nora3 table lamp

2180/3

lampadine
lighting

LED $\hat{=}$ SMD 12W 4000K

flusso luminoso
luminous flux

720 lm

marca LED
LED brand

EPISTAR

classe energetica
energy class

A



2181/3
applique Nora3
Nora3 wall lamp

AFFRALUX s.r.l.

Sede legale | Headquarter:
Via Industria, 13
25011 Calcinato
Frazione Ponte San Marco
BRESCIA - ITALY

Sede operativa | Operational headquarter:
Via Ponticelli, 115
25010 Castenedolo
BRESCIA - ITALY

T +39 030.963.150
F +39 030.996.93.20

info@affralux.com
affralux.com

©DITRE IDEAS MAKERS

graphic artwork
& photo editing
Ditre.com

photo
Quasarfoto.com
Archivio Affralux

printed in Italy
Grafichetagliani.com

Grafiche Tagliani
stampa e comunicazione
March 2019

Il presente catalogo è proprietà dell'azienda AFFRALUX s.r.l.
È vietata la riproduzione, la copia anche parziale e la diffusione
di questo documento attraverso qualsiasi mezzo (telematico,
fotocopia o altro) senza permesso scritto del proprietario.

AFFRALUX s.r.l. si riserva in ogni momento di apportare
migliorie agli articoli, tenendo invariate le caratteristiche
principali dei prodotti. I colori riprodotti su questo catalogo
sono a solo scopo indicativo.

This catalogue is property of AFFRALUX s.r.l.
No part of this document may be reproduced or transmitted in
any form, by any means (electronic, photocopying, recording
or otherwise) without the prior written permission of the owner.

AFFRALUX s.r.l. reserves the right at any time to make
amendments to its products in order to improve the quality, but
keeping unchanged the basic functions and characteristics of
its products. All colours of the objects shown in this catalogue
are just for reference and may differ from the real colours.

